



Walter  
**Cordbarlag**  
für kontrollierte Späne

■ Made  
■ in  
■ Germany



**FRANKEN**  
*Alu-Cut*

Volumenzerspanung in Aluminiumwerkstoffen  
High-Volume Machining in Aluminium Materials



## Nahezu 100 Jahre Präzision und Innovation. Nearly 100 years of precision and innovation.

FRANKEN als Teil der EMUGE-FRANKEN Unternehmensgruppe beschäftigt sich seit seiner Gründung mit der Entwicklung und Produktion von Fräswerkzeugen. Präzision und Innovation prägen das breite Angebot von Fräsern aus Hartmetall und HSS sowie PKD-, CBN- oder wendeplattenbestückten Fräskörpern.

Die Fertigung am deutschen Produktionsstandort in Rückersdorf reicht von Standard-Schaft- und Bohrungsfräsern bis hin zu hochgenauen Form- und Profil-Sonderfräsern. Mit seiner Typen- und Schneidstoffvielfalt, dem hohen Standard und der kompromisslosen Präzision entspricht das Fräserprogramm den höchsten Qualitätsanforderungen.

Als Ergänzung zu den Fräswerkzeugen führen wir ein durchgängiges Programm an Fräsespannmitteln und Zubehör für die verschiedensten Adaptierungsmöglichkeiten.

Ever since its foundation FRANKEN as part of the EMUGE-FRANKEN company association has been developing and manufacturing milling tools. The wide range of end mills of solid carbide and HSS as well as PCD and CBN inserts or milling cutters with indexable inserts is characterised by precision and innovation.

The production in our German manufacturing plant in Rückersdorf includes standard end mills and bore cutters as well as highly precise special form and profile milling tools. With its large variety of tool types and cutting materials, the consistently high standards and uncompromising precision, our product range of milling cutters meets even the highest quality requirements.

In addition to our selection of milling tools, we also offer a comprehensive range of clamping systems, tool holders and accessories.

**EMUGE-FRANKEN ist nach  
ISO 9001:2015 zertifiziert**







EMUGE-FRANKEN is certified  
according ISO 9001:2015











[www.sgs-tuev-saar.com](http://www.sgs-tuev-saar.com)

Certification ID  
DE/819944190



Alu-Cut „Aerospace“						Bestell-Code Order code	Seite Page
Hartmetall-Schaftfräser Solid carbide end mills	<b>WR</b>	Z3 (Flutes)	ICRA			<b>2888 / 2881</b>	6 - 7
	<b>WR</b>	Z3 (Flutes)	ICRA			<b>2890 / 2883</b>	8 - 9
	<b>W</b>	Z3-4 (Flutes)	ICRA			<b>2889 / 2882</b>	10 - 11
	<b>W</b>	Z4 (Flutes)	ICRA			<b>2891 / 2884</b>	12 - 13

Alu-Cut						Bestell-Code Order code	Seite Page
Hartmetall-Schaftfräser Solid carbide end mills	<b>WR</b>	Z3 (Flutes)			<b>2548 / 2549</b>	14 - 15	
	<b>W</b>	Z2-3 (Flutes)			<b>2544 / 2545</b>	16 - 17	
	<b>W</b>	Z3 (Flutes)			<b>2546 / 2547</b>	18 - 19	
Hartmetall-Kugelfräser Solid carbide ball nose end mills	<b>W</b>	Z2 (Flutes)			<b>1921 / 2830 / 1943</b>	20 - 23	
Hartmetall-Torusfräser Solid carbide torus end mills	<b>W</b>	Z2 (Flutes)			<b>1942 / 2838 / 1941</b>	24 - 27	

Alu-Cut HSS						Bestell-Code Order code	Seite Page
HSS-Schaftfräser HSS end mills	<b>WR</b>	Z3 (Flutes)	ICRA			<b>1092 / 1093</b>	28 - 29
	<b>W</b>	Z4 (Flutes)	ICRA			<b>1034 / 1035</b>	30 - 31

Wendeschneidplattenfräser und PKD-Fräser für die Aluminiumbearbeitung Indexable milling cutters and PCD end mills for the machining of aluminium						Seite Page
Rhombische Wendeschneidplattenfräser Rhombic indexable milling cutters						32 - 37
PKD-Plan- und Eckfräser PCD side and face milling cutters						38 - 39

## Alu-Cut Eine neue Dimension bei der Volumenzerspanung in Aluminiumwerkstoffen

Mit der Typenreihe Alu-Cut stellt FRANKEN eine technisch neuartige Fräser-Familie aus Hartmetall und HSSE-PM für die Volumenzerspanung in Aluminiumwerkstoffen. Durch die Kombination von optimalem Schneidstoff, komplett neu entwickelter Schneidengeometrie und Optimierung des Schleifprozesses wurden mit den Werkzeugen der Typenreihe Alu-Cut noch nie da gewesene Zerspanraten erreicht.

Einer der Zielmärkte ist die Luft- und Raumfahrtindustrie. Diese fertigt Bauteile, bei denen bis zu 95% des ursprünglichen Werkstückvolumens zerspannt werden müssen. Hier ist Zeit einer der wichtigsten Faktoren, der maßgeblich durch das erzeugte Spanvolumen, gemessen in Litern pro Minute, beeinflusst wird.

Bei umfangreichen Versuchen wurden Zerspanraten erreicht, welche neue Maßstäbe setzen. Wichtig ist die Spanabfuhr, welche bisher die Grenze des Zeitspanvolumens darstellte. Nun liegt die Grenze bei optimalen Bedingungen bei der Maschinenspindleleistung. Hier ist das zur Verfügung stehende Drehmoment im höheren Drehzahlbereich relevant.

Ergänzt wird die Typenreihe Alu-Cut um rhombische Wendeschneidplatten mit an die Aluminiumbearbeitung angepasster Schneidengeometrie und dazu passenden Einschraub- und Aufsteckfräskörpern.

## Alu-Cut A new dimension in high-volume machining in aluminium materials

FRANKEN introduces the new Alu-Cut, a tool line of radically new solid carbide and HSSE-PM milling cutters for the high-volume machining of aluminium materials. Due to the combination of an optimum cutting material with a newly developed cutting geometry and optimized grinding processes, machining volumes which would have been considered impossible until now can be achieved with the Alu-Cut.

One of the target markets for this new tool type is the aircraft and space industry. Some of the components which are produced in this industry lose up to 95% of their original weight, all through machining processes. Time is one of the most important factors under such circumstances, and it is defined by the machining volume produced, and measured in litres per minute.

In the course of extensive tests, machining volumes were achieved which will set new standards. Especially important is chip evacuation which until now decided the limits of the possible machining volume. Now, the limits are defined only by the performance of the machine spindle, provided that work conditions are otherwise as good as they can be. The available torque in the higher speed ranges is the relevant factor here.

The Alu-Cut line is supplemented both with rhombic inserts with a cutting geometry fitted to the machining of aluminium and suitable indexable screw-in end mills and shell type milling cutters.

### Alu-Cut „Aerospace“ Für die Volumenzerspanung

- ICRA (Kühlschmierstoffaustritt radial und axial)
- Polierte Funktionsflächen

Die Alu-Cut-Serie besteht aus Hartmetall- und HSS-Werkzeugen, die gezielt für die prozesssichere Volumenzerspanung von Aluminium-Knetlegierungen bis 5% Siliziumgehalt entwickelt wurden.

Werkstoffe mit höherem Siliziumgehalt sollten ausschließlich mit beschichteten Werkzeugen bearbeitet werden.

#### Besonderheiten:

- Ungleiche Teilung
- Schruppverzahnung mit grobem WR-Profil
- Spezielle Geometrie zur Aluminium-Bearbeitung
- Optional mit innerer Kühlschmierstoff-Zufuhr mit radialem und axialem Austritt (ICRA)

#### Hauptmerkmal:

Hohes Zeitspanvolumen.

### Alu-Cut „Aerospace“ For volume machining

- ICRA (internal coolant supply, axial exit)
- Polished chip gash

The Alu-Cut series includes tools made from solid carbide and HSS particularly developed for the process-reliable volume machining of wrought aluminum alloys with up to 5% silicon content.

Materials with higher silicon content should preferably be machined with coated tools.

#### Characteristics:

- Variable spacing
- Available with WR profile for roughing
- Special geometry for machining aluminium
- Optionally available with internal coolant supply, radial and axial exit (ICRA)

#### Main feature:

Highest metal removal rate.

### Alu-Cut Die universelle Lösung zur Aluminium-Bearbeitung

Diese neuen Werkzeuge wurden gezielt für die Bearbeitung von Aluminium und Nichteisenmetallen entwickelt. Durch die neue, sehr glatte Beschichtung wird das Werkzeug gegen Aufbauschnittenbildung und Verschleiß geschützt.

#### Besonderheiten:

- Ungleiche Teilung
- Schruppverzahnung mit grobem WR-Profil
- Spezielle Geometrie zur Aluminium-Bearbeitung
- Werkzeuge mit und ohne Eckenradius

#### Hauptmerkmal:

Geeignet zum Fräsen von Aluminium-Knetlegierungen von bis 7% Siliziumgehalt.

### Alu-Cut The versatile solution for machining aluminium

These new tools have been developed for machining aluminium and non-ferrous metals. The new, very smooth coating protects the tool against built-up edge and wear.

#### Characteristics:

- Variable spacing
- Available with WR profile for roughing
- Special geometry for machining aluminium
- Tools with and without corner radii

#### Main feature:

Suitable for milling of Aluminium-alloys with up to 7% Silicon.

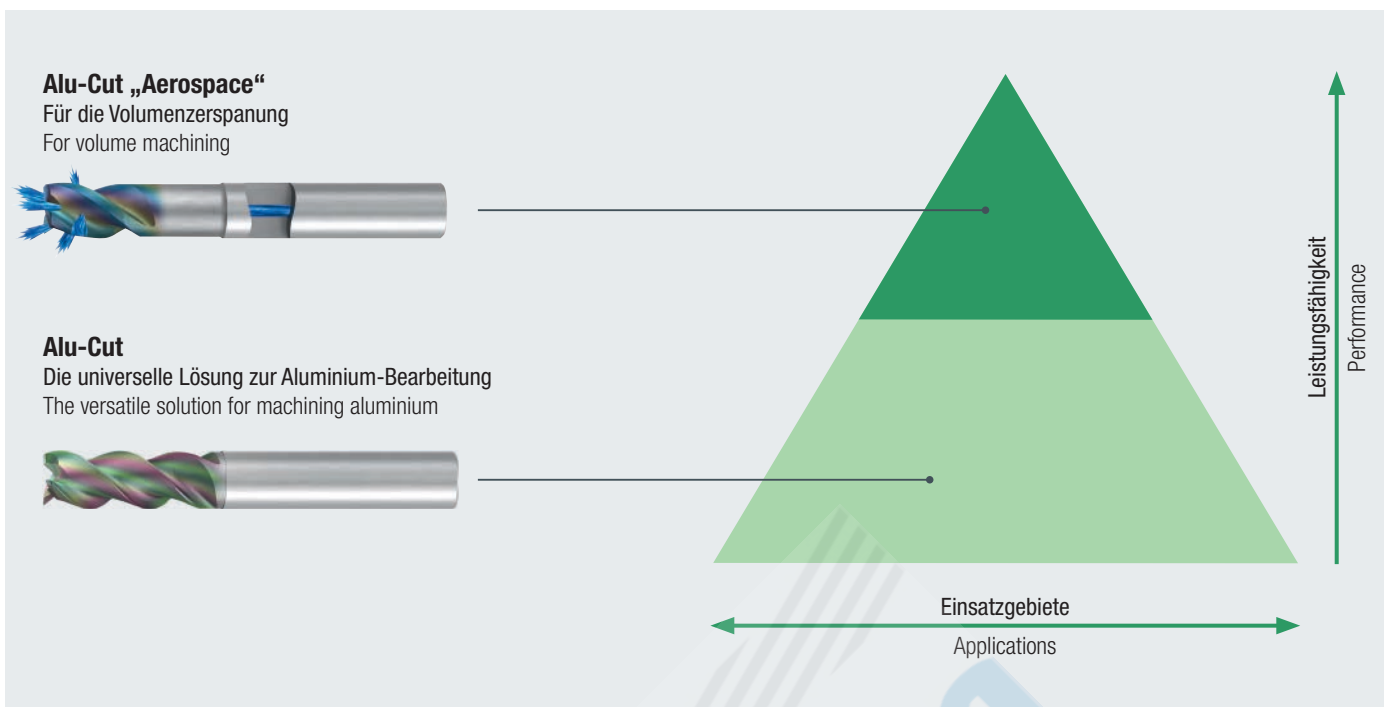

		Einsatzgebiete – Material Applications – material		Material-Beispiele Material examples	Material-Nummern Material numbers	
<b>N</b>	<b>Nichteisenwerkstoffe</b>	<b>Non-ferrous materials</b>				
	<b>Aluminium-Legierungen</b>	<b>Aluminium alloys</b>				
	1.1	Aluminium-Knetlegierungen	Wrought aluminium alloys	≤ 200 N/mm <sup>2</sup>	EN AW-AlMn1Cu	EN AW-3103
					EN AW-Al99,5	EN AW-1050A
				EN AW-AlMg1	EN AW-5005A	
				EN AW-AlMgSi0,5	EN AW-6060	
	1.2			≤ 350 N/mm <sup>2</sup>	EN AW-AlMgSi	EN-AW-6060
					EN AW-AlMg3	EN-AW-5754
		≤ 550 N/mm <sup>2</sup>	EN AW-AlMg2Mn0,8	EN-AW-5049		
	1.3		EN AW-AlMgSi1	EN AW-6082		
				EN AW-AlZn5Mg3Cu	EN AW-7022	
		EN AW-AlMg4,5Mn		EN AW-5083		
		Aluminium-Gusslegierungen	Aluminium cast alloys	Si ≤ 7%	EN AW-AlZn4,5Mg1	EN AW-7020
	1.4				En AW-AlZnMgCu1,5	EN AW-7075
				EN AC-AlMg5	EN AC-51300	
				EN AC-AlSi5Cu3Mg	EN AC-45100	
		7% < Si ≤ 12%	EN AC-AlMg3	EN AC-51100		
	1.5		EN AC-AlSi7Mg0,3	EN AC-42100		
			EN AC-AlSi9Cu3	EN AC-46500		
	EN AC-AlSi10Mg(Cu)		EN AC-43000			
	12% < Si ≤ 17%	EN AC-AlSi12(Fe)	EN AC-44300			
1.6		EN AC-AlSi7Cu2	EN AC-46600			
		EN AC-AlSi17Cu4Mg	EN AC-48100			
			GD-AlSi17Cu4FeMg			
	<b>Kupfer-Legierungen</b>	<b>Copper alloys</b>				
2.1	Reinkupfer, niedriglegiertes Kupfer	Pure copper, low-alloyed copper	≤ 400 N/mm <sup>2</sup>	E-Cu 57	EN CW 004 A	
2.2	Kupfer-Zink-Legierungen (Messing, langspanend)	Copper-zinc alloys (brass, long-chipping)	≤ 550 N/mm <sup>2</sup>	CuZn37 (Ms63)	EN CW 508 L	
2.3	Kupfer-Zink-Legierungen (Messing, kurzspanend)	Copper-zinc alloys (brass, short-chipping)	≤ 550 N/mm <sup>2</sup>	CuZn36Pb3 (Ms58)	EN CW 603 N	
2.4	Kupfer-Aluminium-Legierungen (Alubronze, langspanend)	Copper-aluminium alloys (alu bronze, long-chipping)	≤ 800 N/mm <sup>2</sup>	CuAl10Ni5Fe4	EN CW 307 G	
2.5	Kupfer-Zinn-Legierungen (Zinnbronze, langspanend)	Copper-tin alloys (tin bronze, long-chipping)	≤ 700 N/mm <sup>2</sup>	CuSn8P	EN CW 459 K	
2.6	Kupfer-Zinn-Legierungen (Zinnbronze, kurzspanend)	Copper-tin alloys (tin bronze, short-chipping)	≤ 400 N/mm <sup>2</sup>	CuSn7ZnPb (Rg7)	2.1090	
2.7	Kupfer-Sonderlegierungen	Special copper alloys	≤ 600 N/mm <sup>2</sup>	(AMPCO® 8)		
2.8			≤ 1400 N/mm <sup>2</sup>	(AMPCO® 45)		
	<b>Magnesium-Legierungen</b>	<b>Magnesium alloys</b>				
3.1	Magnesium-Knetlegierungen	Magnesium wrought alloys	≤ 500 N/mm <sup>2</sup>	MgAl6Zn	3.5612	
3.2	Magnesium-Gusslegierungen	Magnesium cast alloys	≤ 500 N/mm <sup>2</sup>	EN MCMgAl9Zn1	EN MC21120	
	<b>Kunststoffe</b>	<b>Synthetics</b>				
4.1	Duroplaste (kurzspanend)	Duroplastics (short-chipping)		Bakelit, Pertinax		
4.2	Thermoplaste (langspanend)	Thermoplastics (long-chipping)		PMMA, POM, PVC		
4.3	Faserverstärkte Kunststoffe (Faseranteil ≤ 30%)	Fibre-reinforced synthetics (fibre content ≤ 30%)		GFK, CFK, AFK		
4.4	Faserverstärkte Kunststoffe (Faseranteil > 30%)	Fibre-reinforced synthetics (fibre content > 30%)		GFK, CFK, AFK		
	<b>Besondere Werkstoffe</b>	<b>Special materials</b>				
5.1	Grafit	Graphite		C 8000		
5.2	Wolfram-Kupfer-Legierungen	Tungsten-copper alloys		W-Cu 80/20		
5.3	Verbundwerkstoffe	Composite materials		Hylite, Alucobond		

- Hochleistungswerkzeug
  - Spezielle Geometrie für die Volumenzerspanung von Aluminium
  - Vibrationsarme Bearbeitung
  - Sehr glatte CRN-Beschichtung
  - Innere Kühlschmierstoff-Zufuhr, Austritt radial und axial (ICRA)
  - Kurze Schneidenlänge
- High performance tool
  - Special geometry for high-volume machining of aluminium
  - Low-vibration machining
  - Very smooth CRN coating
  - Internal coolant supply, radial and axial exit (ICRA)
  - Short flute length

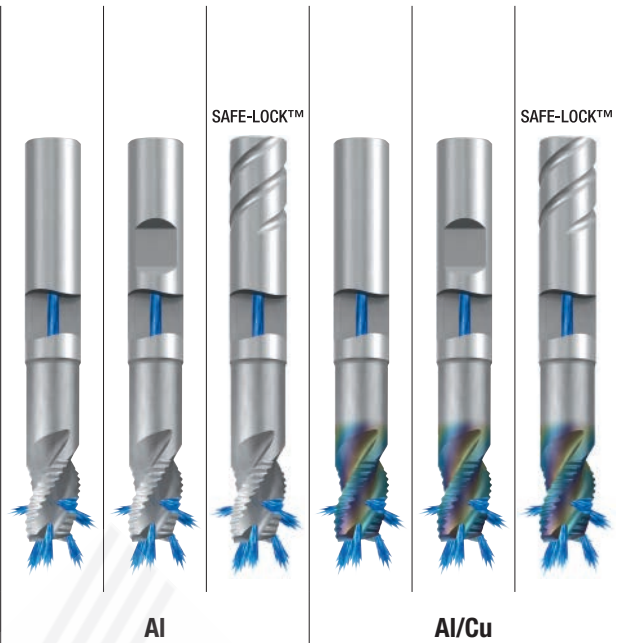
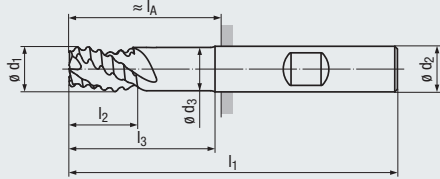
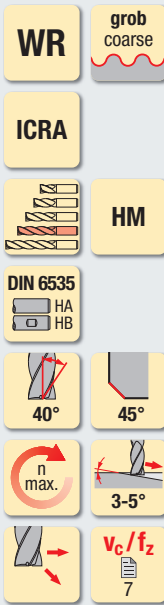

### Beschichtung · Coating

### Einsatzgebiete – Material (siehe Seite 5)

- Für Aluminium-Knetlegierungen
- Für Aluminium-Legierungen mit einem Siliziumgehalt bis 7%
- Mit CRN-Beschichtung auch in Kupfer-Legierungen einsetzbar

### Applications – material (see page 5)

- For wrought aluminium alloys
- For aluminium alloys with a silicon content of up to 7%
- With CRN coating also for copper alloys

**CRN**

N 1.1-1.3 1.4

N 1.1-1.4 2.1-2.7

### Lange Ausführung · Long design

#### Bestell-Code · Order code

$\varnothing d_1$ h11	$l_2$	$l_3$	$l_1$	$\varnothing d_3$	$\varnothing d_2$ h5	$l_A$	$n_{max.}^{2)}$ min <sup>-1</sup>	Z (Flutes)	Dimens.- Code	2888_Z	2881_Z	2888_T	2888RZ	2881RZ	2888RT
<b>6</b> <sup>1)</sup>	8	20	57	5,6	6	21	30000	<b>3</b>	<b>.006</b>	●	●	○	●	●	○
<b>8</b>	10	25	63	7,6	8	27	25000	<b>3</b>	<b>.008</b>	●	●	○	●	●	○
<b>10</b>	13	30	72	9,5	10	32	20000	<b>3</b>	<b>.010</b>	●	●	○	●	●	○
<b>12</b>	15	35	83	11,4	12	38	15000	<b>3</b>	<b>.012</b>	●	●	○	●	●	○
<b>16</b>	20	46	96	15,2	16	48	12500	<b>3</b>	<b>.016</b>	●	●	○	●	●	○
<b>20</b>	25	58	110	19	20	60	10000	<b>3</b>	<b>.020</b>	●	●	○	●	●	○
<b>25</b>	30	73	125	24	25 <sup>3)</sup>	75	8000	<b>3</b>	<b>.025</b>	●	●	○	●	●	○

1) Kühlschmierstoffaustritt axial (ICA)  
Internal coolant supply, axial exit (ICA)

2) Maximal zulässige Drehzahl für Hartmetall-Schaftfräser mit seitlicher Mitnahmefläche nach DIN 6535 HB  
Maximum permissible revolution of solid carbide end mills with clamping flat according to DIN 6535 HB

3) Schaftlänge 50 mm  
Shank length 50 mm



**Hartmetall-Schaftfräser „Aerospace“ – lange Ausführung**  
Solid carbide end mills “Aerospace” – long design

WR

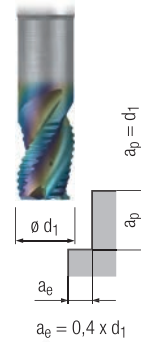
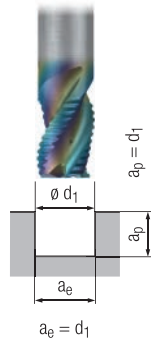

Gültig für · Valid for

- 2881\_Z
- 2881RZ
- 2888\_T
- 2888\_Z
- 2888RT
- 2888RZ

**Achtung:**  
Bei unbeschichteter Ausführung ist die Schnittgeschwindigkeit  $v_c$  um 30% zu reduzieren!

**Please note:**  
For uncoated design, please reduce cutting speed  $v_c$  by 30%!



	$v_c$ [m/min]	$f_z$ [mm]	$v_c$ [m/min]	$f_z$ [mm]				
<b>Nichteisenwerkstoffe · Non-ferrous materials</b>								
<b>Aluminium-Legierungen · Aluminium alloys</b>								
1.1	420	0,009 x $d_1$	630	0,011 x $d_1$			□	■
1.2	620	0,008 x $d_1$	930	0,010 x $d_1$			□	■
1.3	550	0,007 x $d_1$	830	0,008 x $d_1$			□	■
1.4	380	0,008 x $d_1$	570	0,010 x $d_1$			□	■
1.5								
1.6								
<b>Kupfer-Legierungen · Copper alloys</b>								
2.1	120	0,005 x $d_1$	180	0,006 x $d_1$		□	□	■
2.2	120	0,005 x $d_1$	180	0,006 x $d_1$		□	□	■
2.3	120	0,005 x $d_1$	180	0,006 x $d_1$		□	□	■
2.4	110	0,004 x $d_1$	170	0,005 x $d_1$		□	□	■
2.5	110	0,004 x $d_1$	170	0,005 x $d_1$		□	□	■
2.6	110	0,004 x $d_1$	170	0,005 x $d_1$		□	□	■
2.7	70	0,003 x $d_1$	110	0,004 x $d_1$				■
2.8								
<b>Magnesium-Legierungen · Magnesium alloys</b>								
3.1								
3.2								
<b>Kunststoffe · Synthetics</b>								
4.1								
4.2								
4.3								
4.4								
<b>Besondere Werkstoffe · Special materials</b>								
5.1								
5.2								
5.3								

■ = sehr gut geeignet · very suitable  
□ = gut geeignet · suitable

$v_c$  = Schnittgeschwindigkeit · Cutting speed  
 $f_z$  = Vorschub pro Zahn · Feed per tooth

- Hochleistungswerkzeug
  - Spezielle Geometrie für die Volumenzerspanung von Aluminium
  - Vibrationsarme Bearbeitung
  - Sehr glatte CRN-Beschichtung
  - Verschiedene Eckenradien pro Schneidendurchmesser
  - Innere Kühlschmierstoff-Zufuhr, Austritt radial und axial (ICRA)
  - Kurze Schneidenlänge
- High performance tool
  - Special geometry for high-volume machining of aluminium
  - Low-vibration machining
  - Very smooth CRN coating
  - Several corner radii per cutting diameter
  - Internal coolant supply, radial and axial exit (ICRA)
  - Short flute length

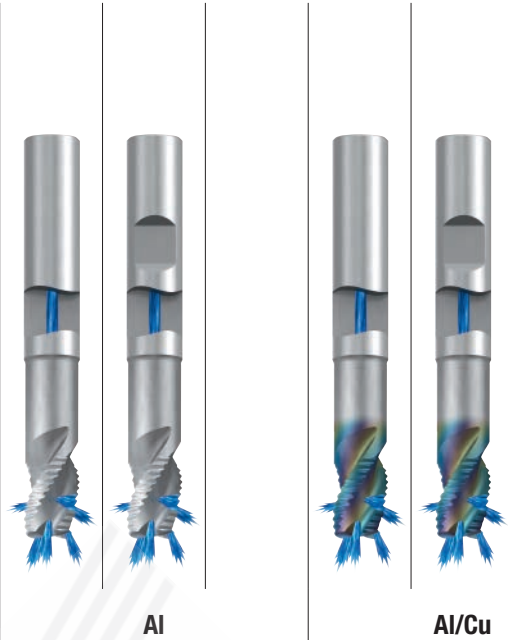
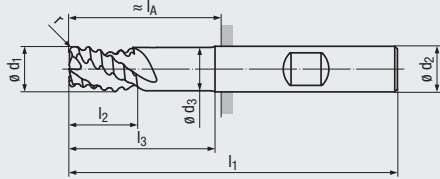

### Beschichtung · Coating

#### Einsatzgebiete – Material (siehe Seite 5)

- Für Aluminium-Knetlegierungen
- Für Aluminium-Legierungen mit einem Siliziumgehalt bis 7%
- Mit CRN-Beschichtung auch in Kupfer-Legierungen einsetzbar

#### Applications – material (see page 5)

- For wrought aluminium alloys
- For aluminium alloys with a silicon content of up to 7%
- With CRN coating also for copper alloys

**CRN**

N 1.1-1.3 1.4

N 1.1-1.4 2.1-2.7

### Lange Ausführung · Long design

### Eckenradius · Corner radius

Bestell-Code · Order code											2890 Z	2883 Z	2890RZ	2883RZ
$\varnothing d_1$ h11	r	$l_2$	$l_3$	$l_1$	$\varnothing d_3$	$\varnothing d_2$ h5	$l_A$	$n_{max.}^{2)}$ min <sup>-1</sup>	Z (Flutes)	Dimens.- Code				
12	2	15	35	83	11,4	12	38	15000	3	.012020	●	●	●	●
12	2,5	15	35	83	11,4	12	38	15000	3	.012025	●	●	●	●
12	3	15	35	83	11,4	12	38	15000	3	.012030	●	●	●	●
12	4	15	35	83	11,4	12	38	15000	3	.012040	●	●	●	●
16	2	20	46	96	15,2	16	48	12500	3	.016020	●	●	●	●
16	2,5	20	46	96	15,2	16	48	12500	3	.016025	●	●	●	●
16	3	20	46	96	15,2	16	48	12500	3	.016030	●	●	●	●
16	4	20	46	96	15,2	16	48	12500	3	.016040	●	●	●	●
20	2	25	58	110	19	20	60	10000	3	.020020	●	●	●	●
20	2,5	25	58	110	19	20	60	10000	3	.020025	●	●	●	●
20	3	25	58	110	19	20	60	10000	3	.020030	●	●	●	●
20	4	25	58	110	19	20	60	10000	3	.020040	●	●	●	●
25	2	30	73	125	24	25 <sup>3)</sup>	75	8000	3	.025020	●	●	●	●
25	2,5	30	73	125	24	25 <sup>3)</sup>	75	8000	3	.025025	●	●	●	●
25	3	30	73	125	24	25 <sup>3)</sup>	75	8000	3	.025030	●	●	●	●
25	4	30	73	125	24	25 <sup>3)</sup>	75	8000	3	.025040	●	●	●	●

Andere Eckenradien auf Anfrage lieferbar  
Other corner radii available on request

<sup>2)</sup> Maximal zulässige Drehzahl für Hartmetall-Schaftfräser mit seitlicher Mitnahmefläche nach DIN 6535 HB  
Maximum permissible revolution of solid carbide end mills with clamping flat according to DIN 6535 HB

<sup>3)</sup> Schaftlänge 50 mm  
Shank length 50 mm





**Hartmetall-Schaftfräser „Aerospace“ – lange Ausführung**  
Solid carbide end mills “Aerospace” – long design

WR

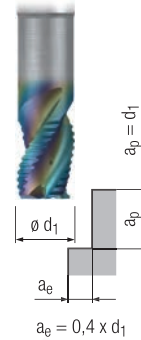
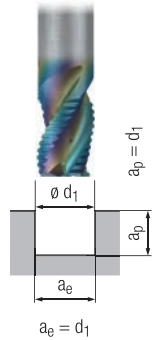

Gültig für · Valid for

- 2883\_Z
- 2883RZ
- 2890\_Z
- 2890RZ

**Achtung:**  
Bei unbeschichteter Ausführung ist die Schnittgeschwindigkeit  $v_c$  um 30% zu reduzieren!

**Please note:**  
For uncoated design, please reduce cutting speed  $v_c$  by 30%!



	$v_c$ [m/min]	$f_z$ [mm]	$v_c$ [m/min]	$f_z$ [mm]				
<b>Nichteisenwerkstoffe · Non-ferrous materials</b>								
<b>Aluminium-Legierungen · Aluminium alloys</b>								
1.1	420	0,009 x $d_1$	630	0,011 x $d_1$			□	■
1.2	620	0,008 x $d_1$	930	0,010 x $d_1$			□	■
1.3	550	0,007 x $d_1$	830	0,008 x $d_1$			□	■
1.4	380	0,008 x $d_1$	570	0,010 x $d_1$			□	■
1.5								
1.6								
<b>Kupfer-Legierungen · Copper alloys</b>								
2.1	120	0,005 x $d_1$	180	0,006 x $d_1$		□	□	■
2.2	120	0,005 x $d_1$	180	0,006 x $d_1$		□	□	■
2.3	120	0,005 x $d_1$	180	0,006 x $d_1$		□	□	■
2.4	110	0,004 x $d_1$	170	0,005 x $d_1$		□	□	■
2.5	110	0,004 x $d_1$	170	0,005 x $d_1$		□	□	■
2.6	110	0,004 x $d_1$	170	0,005 x $d_1$		□	□	■
2.7	70	0,003 x $d_1$	110	0,004 x $d_1$				■
2.8								
<b>Magnesium-Legierungen · Magnesium alloys</b>								
3.1								
3.2								
<b>Kunststoffe · Synthetics</b>								
4.1								
4.2								
4.3								
4.4								
<b>Besondere Werkstoffe · Special materials</b>								
5.1								
5.2								
5.3								

■ = sehr gut geeignet · very suitable  
□ = gut geeignet · suitable

$v_c$  = Schnittgeschwindigkeit · Cutting speed  
 $f_z$  = Vorschub pro Zahn · Feed per tooth

- Hochleistungswerkzeug
- Spezielle Geometrie für die Volumenerspannung von Aluminium
- Vibrationsarme Bearbeitung
- Sehr glatte CRN-Beschichtung
- Innere Kühlschmierstoff-Zufuhr, Austritt radial und axial (ICRA)
- Kurze Schneidenlänge

- High performance tool
- Special geometry for high-volume machining of aluminium
- Low-vibration machining
- Very smooth CRN coating
- Internal coolant supply, radial and axial exit (ICRA)
- Short flute length

**W**

**ICRA**

**HM**

**DIN 6535**  
HA  
HB

**40°**

**KB x 45°**

**n max.**

**3-5°**

**V<sub>c</sub>/f<sub>z</sub>**  
11

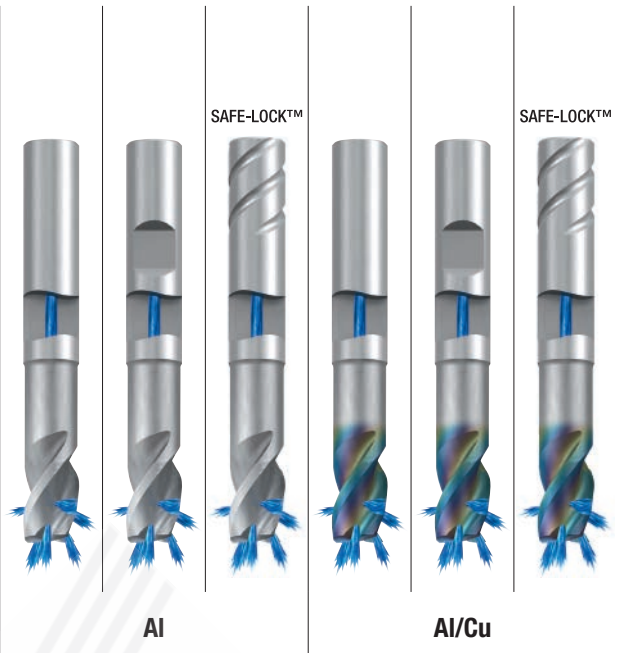
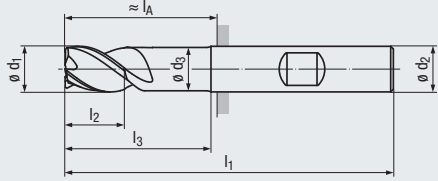

**Beschichtung · Coating**

**Einsatzgebiete – Material (siehe Seite 5)**

- Für Aluminium-Knetlegierungen
- Für Aluminium-Legierungen mit einem Siliziumgehalt bis 7%
- Mit CRN-Beschichtung auch in Kupfer-Legierungen einsetzbar

**Applications – material (see page 5)**

- For wrought aluminium alloys
- For aluminium alloys with a silicon content of up to 7%
- With CRN coating also for copper alloys

**CRN**

N 1.1-1.3 1.4

N 1.1-1.4 2.1-2.7

**Lange Ausführung · Long design**

Bestell-Code · Order code											2889_Z	2882_Z	2889_T	2889RZ	2882RZ	2889RT
Ø d <sub>1</sub>	l <sub>2</sub>	l <sub>3</sub>	l <sub>1</sub>	Ø d <sub>3</sub>	Ø d <sub>2</sub> h5	l <sub>A</sub>	n <sub>max.</sub> <sup>2)</sup> min <sup>-1</sup>	KB	Z (Flutes)	Dimens.- Code						
<b>6 1)</b> -0,02	8	20	57	5,6	6	21	30000	0,12	<b>3</b>	<b>.006</b>	●	●	○	●	●	○
<b>8</b> -0,04	10	25	63	7,6	8	27	25000	0,12	<b>3</b>	<b>.008</b>	●	●	○	●	●	○
<b>10</b> -0,04	13	30	72	9,5	10	32	20000	0,2	<b>3</b>	<b>.010</b>	●	●	○	●	●	○
<b>12</b> -0,04	15	35	83	11,4	12	38	15000	0,2	<b>4</b>	<b>.012</b>	●	●	○	●	●	○
<b>16</b> -0,04	20	46	96	15,2	16	48	12500	0,2	<b>4</b>	<b>.016</b>	●	●	○	●	●	○
<b>20</b> -0,04	25	58	110	19	20	60	10000	0,3	<b>4</b>	<b>.020</b>	●	●	○	●	●	○
<b>25</b> -0,04	30	73	125	24	25 <sup>3)</sup>	75	8000	0,3	<b>4</b>	<b>.025</b>	●	●	○	●	●	○

1) Kühlschmierstoffaustritt axial (ICA)  
Internal coolant supply, axial exit (ICA)

2) Maximal zulässige Drehzahl für Hartmetall-Schaftfräser mit seitlicher Mitnahmefläche nach DIN 6535 HB  
Maximum permissible revolution of solid carbide end mills with clamping flat according to DIN 6535 HB

3) Schaftlänge 50 mm  
Shank length 50 mm



**Hartmetall-Schaftfräser „Aerospace“ – lange Ausführung**  
Solid carbide end mills “Aerospace” – long design

W

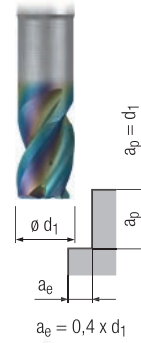
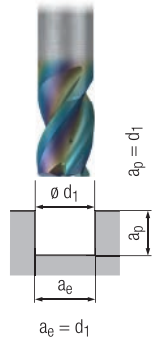

Gültig für · Valid for

- 2882\_Z
- 2882RZ
- 2889\_T
- 2889\_Z
- 2889RT
- 2889RZ

**Achtung:**  
Bei unbeschichteter Ausführung ist die Schnittgeschwindigkeit  $v_c$  um 30% zu reduzieren!

**Please note:**  
For uncoated design, please reduce cutting speed  $v_c$  by 30%!



	$v_c$ [m/min]	$f_z$ [mm]	$v_c$ [m/min]	$f_z$ [mm]				
<b>Nichteisenwerkstoffe · Non-ferrous materials</b>								
<b>Aluminium-Legierungen · Aluminium alloys</b>								
1.1	420	0,008 x $d_1$	760	0,011 x $d_1$			<input type="checkbox"/>	<input checked="" type="checkbox"/>
1.2	620	0,007 x $d_1$	1120	0,010 x $d_1$			<input type="checkbox"/>	<input checked="" type="checkbox"/>
1.3	550	0,006 x $d_1$	990	0,008 x $d_1$			<input type="checkbox"/>	<input checked="" type="checkbox"/>
1.4	380	0,007 x $d_1$	680	0,010 x $d_1$			<input type="checkbox"/>	<input checked="" type="checkbox"/>
1.5								
1.6								
<b>Kupfer-Legierungen · Copper alloys</b>								
2.1	120	0,005 x $d_1$	220	0,006 x $d_1$		<input type="checkbox"/>	<input type="checkbox"/>	<input checked="" type="checkbox"/>
2.2	120	0,005 x $d_1$	220	0,006 x $d_1$		<input type="checkbox"/>	<input type="checkbox"/>	<input checked="" type="checkbox"/>
2.3	120	0,005 x $d_1$	220	0,006 x $d_1$		<input type="checkbox"/>	<input type="checkbox"/>	<input checked="" type="checkbox"/>
2.4	110	0,004 x $d_1$	200	0,005 x $d_1$		<input type="checkbox"/>	<input type="checkbox"/>	<input checked="" type="checkbox"/>
2.5	110	0,004 x $d_1$	200	0,005 x $d_1$		<input type="checkbox"/>	<input type="checkbox"/>	<input checked="" type="checkbox"/>
2.6	110	0,004 x $d_1$	200	0,005 x $d_1$		<input type="checkbox"/>	<input type="checkbox"/>	<input checked="" type="checkbox"/>
2.7	70	0,003 x $d_1$	130	0,004 x $d_1$				<input checked="" type="checkbox"/>
2.8								
<b>Magnesium-Legierungen · Magnesium alloys</b>								
3.1								
3.2								
<b>Kunststoffe · Synthetics</b>								
4.1								
4.2								
4.3								
4.4								
<b>Besondere Werkstoffe · Special materials</b>								
5.1								
5.2								
5.3								

■ = sehr gut geeignet · very suitable  
□ = gut geeignet · suitable

$v_c$  = Schnittgeschwindigkeit · Cutting speed  
 $f_z$  = Vorschub pro Zahn · Feed per tooth

- Hochleistungswerkzeug
- Spezielle Geometrie für die Volumenzerspanung von Aluminium
- Vibrationsarme Bearbeitung
- Sehr glatte CRN-Beschichtung
- Verschiedene Eckenradien pro Schneidendurchmesser
- Innere Kühlschmierstoff-Zufuhr, Austritt radial und axial (ICRA)
- Kurze Schneidenlänge

- High performance tool
- Special geometry for high-volume machining of aluminium
- Low-vibration machining
- Very smooth CRN coating
- Several corner radii per cutting diameter
- Internal coolant supply, radial and axial exit (ICRA)
- Short flute length

**W**

**ICRA**

**HM**

**DIN 6535**  
HA  
HB

**40°**

**ER**

**n max.**

**3-5°**

**V<sub>c</sub>/f<sub>z</sub>**  
13

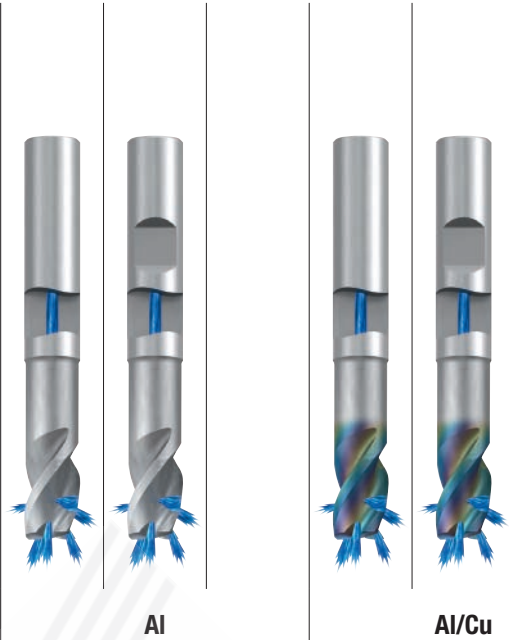
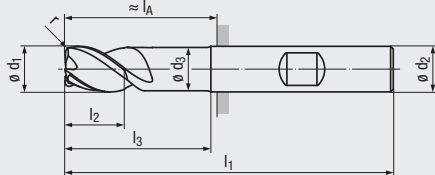

**Beschichtung · Coating**

**Einsatzgebiete – Material (siehe Seite 5)**

- Für Aluminium-Knetlegierungen
- Für Aluminium-Legierungen mit einem Siliziumgehalt bis 7%
- Mit CRN-Beschichtung auch in Kupfer-Legierungen einsetzbar

**Applications – material (see page 5)**

- For wrought aluminium alloys
- For aluminium alloys with a silicon content of up to 7%
- With CRN coating also for copper alloys

**CRN**

N 1.1-1.3 1.4

N 1.1-1.4 2.1-2.7

**Lange Ausführung · Long design**

**Eckenradius · Corner radius**

Bestell-Code · Order code											Eckenradius · Corner radius			
Ø d <sub>1</sub> -0,04	r	l <sub>2</sub>	l <sub>3</sub>	l <sub>1</sub>	Ø d <sub>3</sub>	Ø d <sub>2</sub> h <sub>5</sub>	l <sub>A</sub>	n <sub>max.</sub> <sup>2)</sup> min <sup>-1</sup>	Z (Flutes)	Dimens.- Code	2891 Z	2884 Z	2891RZ	2884RZ
12	2	15	35	83	11,4	12	38	15000	4	.012020	●	●	●	●
12	2,5	15	35	83	11,4	12	38	15000	4	.012025	●	●	●	●
12	3	15	35	83	11,4	12	38	15000	4	.012030	●	●	●	●
12	4	15	35	83	11,4	12	38	15000	4	.012040	●	●	●	●
16	2	20	46	96	15,2	16	48	12500	4	.016020	●	●	●	●
16	2,5	20	46	96	15,2	16	48	12500	4	.016025	●	●	●	●
16	3	20	46	96	15,2	16	48	12500	4	.016030	●	●	●	●
16	4	20	46	96	15,2	16	48	12500	4	.016040	●	●	●	●
20	2	25	58	110	19	20	60	10000	4	.020020	●	●	●	●
20	2,5	25	58	110	19	20	60	10000	4	.020025	●	●	●	●
20	3	25	58	110	19	20	60	10000	4	.020030	●	●	●	●
20	4	25	58	110	19	20	60	10000	4	.020040	●	●	●	●
25	2	30	73	125	24	25 <sup>3)</sup>	75	8000	4	.025020	●	●	●	●
25	2,5	30	73	125	24	25 <sup>3)</sup>	75	8000	4	.025025	●	●	●	●
25	3	30	73	125	24	25 <sup>3)</sup>	75	8000	4	.025030	●	●	●	●
25	4	30	73	125	24	25 <sup>3)</sup>	75	8000	4	.025040	●	●	●	●

Andere Eckenradien auf Anfrage lieferbar  
Other corner radii available on request

<sup>2)</sup> Maximal zulässige Drehzahl für Hartmetall-Schaftfräser mit seitlicher Mitnahmefläche nach DIN 6535 HB  
Maximum permissible revolution of solid carbide end mills with clamping flat according to DIN 6535 HB

<sup>3)</sup> Schaftlänge 50 mm  
Shank length 50 mm



**Hartmetall-Schaftfräser „Aerospace“ – lange Ausführung**  
Solid carbide end mills “Aerospace” – long design

W

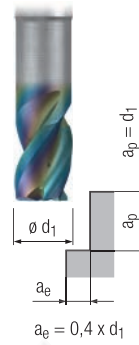
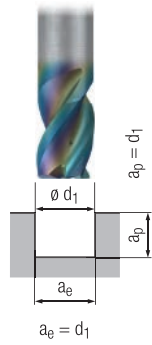

Gültig für · Valid for

- 2884\_Z
- 2884RZ
- 2891\_Z
- 2891RZ

**Achtung:**  
Bei unbeschichteter Ausführung ist die Schnittgeschwindigkeit  $v_c$  um 30% zu reduzieren!

**Please note:**  
For uncoated design, please reduce cutting speed  $v_c$  by 30%!



	$v_c$ [m/min]	$f_z$ [mm]	$v_c$ [m/min]	$f_z$ [mm]				
<b>Nichteisenwerkstoffe · Non-ferrous materials</b>								
<b>Aluminium-Legierungen · Aluminium alloys</b>								
1.1	420	0,008 x $d_1$	760	0,011 x $d_1$			<input type="checkbox"/>	<input checked="" type="checkbox"/>
1.2	620	0,007 x $d_1$	1120	0,010 x $d_1$			<input type="checkbox"/>	<input checked="" type="checkbox"/>
1.3	550	0,006 x $d_1$	990	0,008 x $d_1$			<input type="checkbox"/>	<input checked="" type="checkbox"/>
1.4	380	0,007 x $d_1$	680	0,010 x $d_1$			<input type="checkbox"/>	<input checked="" type="checkbox"/>
1.5								
1.6								
<b>Kupfer-Legierungen · Copper alloys</b>								
2.1	120	0,005 x $d_1$	220	0,006 x $d_1$		<input type="checkbox"/>	<input type="checkbox"/>	<input checked="" type="checkbox"/>
2.2	120	0,005 x $d_1$	220	0,006 x $d_1$		<input type="checkbox"/>	<input type="checkbox"/>	<input checked="" type="checkbox"/>
2.3	120	0,005 x $d_1$	220	0,006 x $d_1$		<input type="checkbox"/>	<input type="checkbox"/>	<input checked="" type="checkbox"/>
2.4	110	0,004 x $d_1$	200	0,005 x $d_1$		<input type="checkbox"/>	<input type="checkbox"/>	<input checked="" type="checkbox"/>
2.5	110	0,004 x $d_1$	200	0,005 x $d_1$		<input type="checkbox"/>	<input type="checkbox"/>	<input checked="" type="checkbox"/>
2.6	110	0,004 x $d_1$	200	0,005 x $d_1$		<input type="checkbox"/>	<input type="checkbox"/>	<input checked="" type="checkbox"/>
2.7	70	0,003 x $d_1$	130	0,004 x $d_1$				<input checked="" type="checkbox"/>
2.8								
<b>Magnesium-Legierungen · Magnesium alloys</b>								
3.1								
3.2								
<b>Kunststoffe · Synthetics</b>								
4.1								
4.2								
4.3								
4.4								
<b>Besondere Werkstoffe · Special materials</b>								
5.1								
5.2								
5.3								

■ = sehr gut geeignet · very suitable  
□ = gut geeignet · suitable

$v_c$  = Schnittgeschwindigkeit · Cutting speed  
 $f_z$  = Vorschub pro Zahn · Feed per tooth

- Hochleistungswerkzeug
- Spezielle Geometrie für die Aluminiumzerspanung
- Schneiden zur Mitte

- High performance tool
- Special geometry for the machining of aluminium
- Centre cutting

**WR** **grob coarse**

**HM**

**DIN 6535**  
HA  
HB

**40°** **45°**

**3-5°**

**$v_c/f_z$**   
**15**

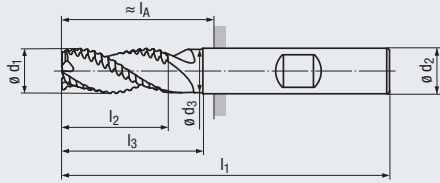

Design  $l_4$ :

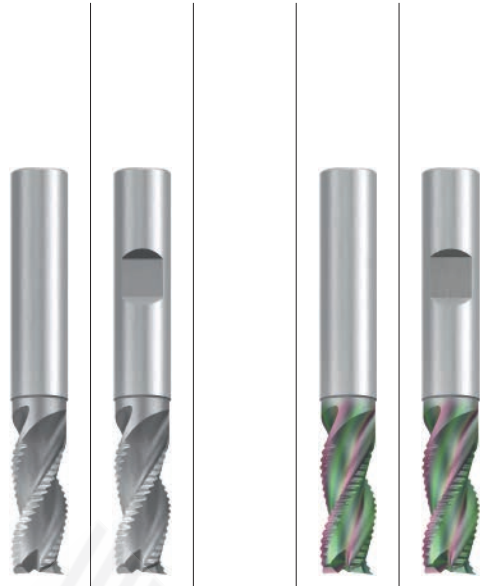
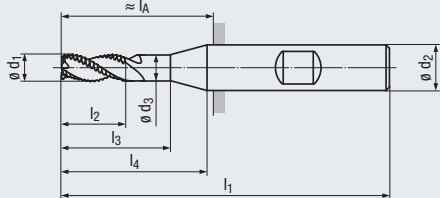

AI

Al/Cu

Beschichtung · Coating

**GLT**

Einsatzgebiete – Material (siehe Seite 5)

Applications – material (see page 5)

- Für Aluminium-Knetlegierungen
- Für Aluminium-Legierungen mit einem Siliziumgehalt bis 7%
- Mit GLT-Beschichtung auch in Kupfer-Legierungen einsetzbar

- For wrought aluminium alloys
- For aluminium alloys with a silicon content of up to 7%
- With GLT coating also for copper alloys

N 1.1-1.3 1.4

N 1.1-1.4 2.1-2.7

## DIN 6527 – Lange Ausführung · Long design

Bestell-Code · Order code										2548	2549	2548K	2549K
$\varnothing d_1$ h11	$l_2$	$l_3$	$l_1$	$\varnothing d_3$	$l_4$	$\varnothing d_2$ h6	$l_A$ 	Z (Flutes)	Dimens.- Code				
3	7	14	57	2,9	20	6	21	3	.003	●	●	●	●
4	8	18	57	3,8	20	6	21	3	.004	●	●	●	●
5	10	19	57	4,8	20	6	21	3	.005	●	●	●	●
6	13	20	57	5,8	–	6	21	3	.006	●	●	●	●
8	19	25	63	7,7	–	8	34	3	.008	●	●	●	●
10	22	30	72	9,5	–	10	32	3	.010	●	●	●	●
12	26	35	83	11,5	–	12	38	3	.012	●	●	●	●
16	32	40	92	15,5	–	16	44	3	.016	●	●	●	●
20	38	50	104	19,5	–	20	54	3	.020	●	●	●	●



**Hartmetall-Schaftfräser – lange Ausführung**  
Solid carbide end mills – long design

WR

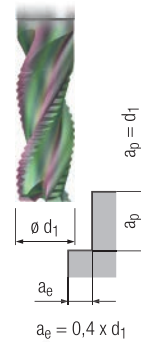
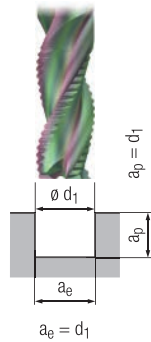

Gültig für · Valid for

- 2548
- 2548K
- 2549
- 2549K

**Achtung:**  
Bei unbeschichteter Ausführung ist die Schnittgeschwindigkeit  $v_c$  um 30% zu reduzieren!

**Please note:**  
For uncoated design, please reduce cutting speed  $v_c$  by 30%!



	$v_c$ [m/min]	$f_z$ [mm]	$v_c$ [m/min]	$f_z$ [mm]				
<b>Nichteisenwerkstoffe · Non-ferrous materials</b>								
<b>Aluminium-Legierungen · Aluminium alloys</b>								
1.1	300	0,009 x $d_1$	420	0,011 x $d_1$			<input type="checkbox"/>	<input checked="" type="checkbox"/>
1.2	430	0,008 x $d_1$	620	0,010 x $d_1$			<input type="checkbox"/>	<input checked="" type="checkbox"/>
1.3	385	0,007 x $d_1$	550	0,008 x $d_1$			<input type="checkbox"/>	<input checked="" type="checkbox"/>
1.4	270	0,008 x $d_1$	380	0,010 x $d_1$			<input type="checkbox"/>	<input checked="" type="checkbox"/>
1.5								
1.6								
<b>Kupfer-Legierungen · Copper alloys</b>								
2.1	100	0,005 x $d_1$	160	0,006 x $d_1$		<input type="checkbox"/>	<input type="checkbox"/>	<input checked="" type="checkbox"/>
2.2	100	0,005 x $d_1$	160	0,006 x $d_1$		<input type="checkbox"/>	<input type="checkbox"/>	<input checked="" type="checkbox"/>
2.3	100	0,005 x $d_1$	160	0,006 x $d_1$		<input type="checkbox"/>	<input type="checkbox"/>	<input checked="" type="checkbox"/>
2.4	80	0,004 x $d_1$	140	0,005 x $d_1$		<input type="checkbox"/>	<input type="checkbox"/>	<input checked="" type="checkbox"/>
2.5	80	0,004 x $d_1$	140	0,005 x $d_1$		<input type="checkbox"/>	<input type="checkbox"/>	<input checked="" type="checkbox"/>
2.6	80	0,004 x $d_1$	140	0,005 x $d_1$		<input type="checkbox"/>	<input type="checkbox"/>	<input checked="" type="checkbox"/>
2.7	60	0,003 x $d_1$	100	0,004 x $d_1$				<input checked="" type="checkbox"/>
2.8								
<b>Magnesium-Legierungen · Magnesium alloys</b>								
3.1								
3.2								
<b>Kunststoffe · Synthetics</b>								
4.1								
4.2								
4.3								
4.4								
<b>Besondere Werkstoffe · Special materials</b>								
5.1								
5.2								
5.3								

■ = sehr gut geeignet · very suitable  
□ = gut geeignet · suitable

$v_c$  = Schnittgeschwindigkeit · Cutting speed  
 $f_z$  = Vorschub pro Zahn · Feed per tooth

- Hochleistungswerkzeug
- Spezielle Geometrie für die Aluminiumzerspanung
- Vibrationsarme Bearbeitung
- Mit 2 und 3 Schneiden
- Schneiden zur Mitte

- High performance tool
- Special geometry for the machining of aluminium
- Low-vibration machining
- With 2 and 3 flutes
- Centre cutting

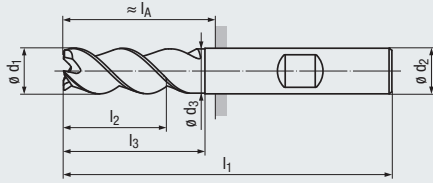

Design  $l_4$ :

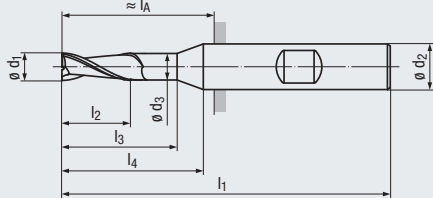

**W**

**HM**

**DIN 6535**  
HA  
HB

**Z2**  
45°

**Z3**  
38-40°

**KB x 45°**

**$v_c/f_z$**   
17

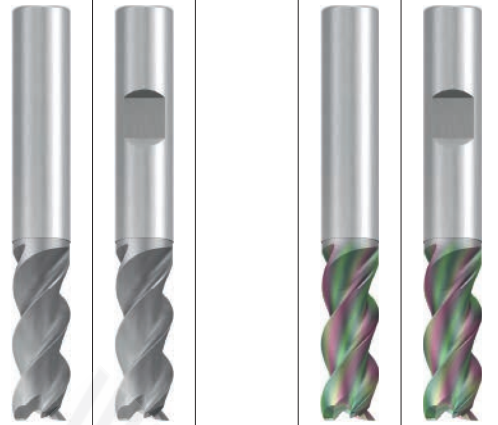

AI

Al/Cu

**Beschichtung · Coating**

**Einsatzgebiete – Material (siehe Seite 5)**

- Für Aluminium-Knetlegierungen
- Für Aluminium-Legierungen mit einem Siliziumgehalt bis 7%
- Mit GLT-Beschichtung auch in Kupfer-Legierungen einsetzbar
- Zum Bohrfräsen geeignet
- Zum Schruppen und Schlichten geeignet

**Applications – material (see page 5)**

- For wrought aluminium alloys
- For aluminium alloys with a silicon content of up to 7%
- With GLT coating also for copper alloys
- Suitable for z-axis milling
- Suitable for roughing and finishing

**GLT**

N 1.1-1.3 1.4

N 1.1-1.4 2.1-2.7

**DIN 6527 – Lange Ausführung · Long design**

Bestell-Code · Order code											2544	2545	2544K	2545K
$\varnothing d_1$ h10	$l_2$	$l_3$	$l_1$	$\varnothing d_3$	$l_4$	$\varnothing d_2$ h6	$l_A$ □	KB	Z (Flutes)	Dimens.- Code				
2	6	10	57	1,9	20	6	21	0,06	2	.002	●	●	●	●
3	7	14	57	2,9	20	6	21	0,1	2	.003	●	●	●	●
4	8	18	57	3,8	20	6	21	0,1	2	.004	●	●	●	●
5	10	19	57	4,8	20	6	21	0,15	2	.005	●	●	●	●
6	13	20	57	5,8	–	6	21	0,125	3	.006	●	●	●	●
8	19	25	63	7,7	–	8	34	0,125	3	.008	●	●	●	●
10	22	30	72	9,5	–	10	32	0,2	3	.010	●	●	●	●
12	26	35	83	11,5	–	12	38	0,2	3	.012	●	●	●	●
16	32	40	92	15,5	–	16	44	0,2	3	.016	●	●	●	●
20	38	50	104	19,5	–	20	54	0,3	3	.020	●	●	●	●





**Hartmetall-Schaftfräser – lange Ausführung**  
Solid carbide end mills – long design

W

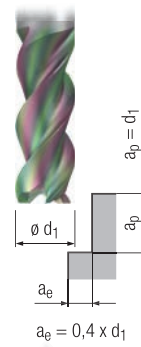
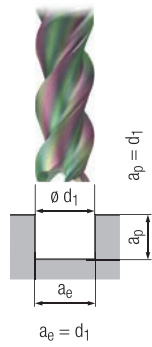

Gültig für · Valid for

- 2544
- 2544K
- 2545
- 2545K

**Achtung:**  
Bei unbeschichteter Ausführung ist die Schnittgeschwindigkeit  $v_c$  um 30% zu reduzieren!

**Please note:**  
For uncoated design, please reduce cutting speed  $v_c$  by 30%!



	$v_c$ [m/min]	$f_z$ [mm]	$v_c$ [m/min]	$f_z$ [mm]				
<b>Nichteisenwerkstoffe · Non-ferrous materials</b>								
<b>Aluminium-Legierungen · Aluminium alloys</b>								
1.1	300	$0,006 \times d_1$	420	$0,011 \times d_1$			<input type="checkbox"/>	<input checked="" type="checkbox"/>
1.2	430	$0,005 \times d_1$	620	$0,010 \times d_1$			<input type="checkbox"/>	<input checked="" type="checkbox"/>
1.3	385	$0,005 \times d_1$	550	$0,008 \times d_1$			<input type="checkbox"/>	<input checked="" type="checkbox"/>
1.4	270	$0,005 \times d_1$	380	$0,010 \times d_1$			<input type="checkbox"/>	<input checked="" type="checkbox"/>
1.5								
1.6								
<b>Kupfer-Legierungen · Copper alloys</b>								
2.1	100	$0,005 \times d_1$	160	$0,006 \times d_1$		<input type="checkbox"/>	<input type="checkbox"/>	<input checked="" type="checkbox"/>
2.2	100	$0,005 \times d_1$	160	$0,006 \times d_1$		<input type="checkbox"/>	<input type="checkbox"/>	<input checked="" type="checkbox"/>
2.3	100	$0,005 \times d_1$	160	$0,006 \times d_1$		<input type="checkbox"/>	<input type="checkbox"/>	<input checked="" type="checkbox"/>
2.4	80	$0,004 \times d_1$	140	$0,005 \times d_1$		<input type="checkbox"/>	<input type="checkbox"/>	<input checked="" type="checkbox"/>
2.5	80	$0,004 \times d_1$	140	$0,005 \times d_1$		<input type="checkbox"/>	<input type="checkbox"/>	<input checked="" type="checkbox"/>
2.6	80	$0,004 \times d_1$	140	$0,005 \times d_1$		<input type="checkbox"/>	<input type="checkbox"/>	<input checked="" type="checkbox"/>
2.7	60	$0,003 \times d_1$	100	$0,004 \times d_1$				<input checked="" type="checkbox"/>
2.8								
<b>Magnesium-Legierungen · Magnesium alloys</b>								
3.1								
3.2								
<b>Kunststoffe · Synthetics</b>								
4.1								
4.2								
4.3								
4.4								
<b>Besondere Werkstoffe · Special materials</b>								
5.1								
5.2								
5.3								

■ = sehr gut geeignet · very suitable  
□ = gut geeignet · suitable

$v_c$  = Schnittgeschwindigkeit · Cutting speed  
 $f_z$  = Vorschub pro Zahn · Feed per tooth

- Hochleistungswerkzeug
- Spezielle Geometrie für die Aluminiumzerspanung
- Vibrationsarme Bearbeitung
- Verschiedene Eckenradien pro Schneidendurchmesser
- Schneiden zur Mitte

- High performance tool
- Special geometry for the machining of aluminium
- Low-vibration machining
- Several corner radii per cutting diameter
- Centre cutting

**W**

**HM**

**DIN 6535**  
HA  
HB

**38-40°**

**ER**

**V<sub>c</sub>/f<sub>z</sub>**  
19

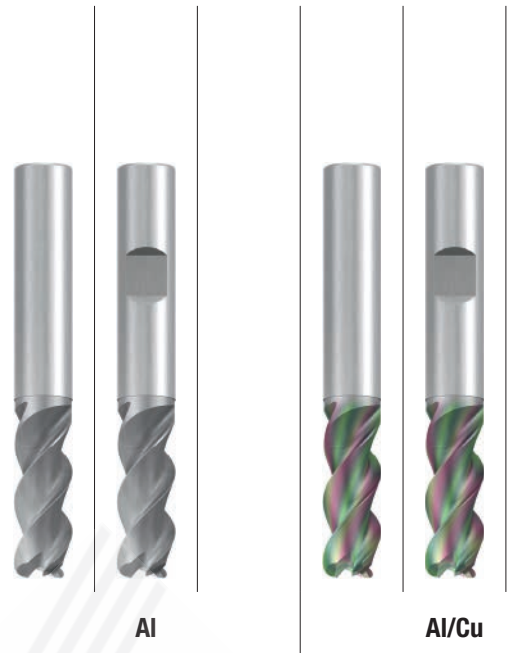
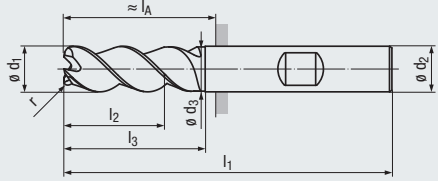

**Beschichtung · Coating**

- Einsatzgebiete – Material (siehe Seite 5)**
- Für Aluminium-Knetlegierungen
  - Für Aluminium-Legierungen mit einem Siliziumgehalt bis 7%
  - Mit GLT-Beschichtung auch in Kupfer-Legierungen einsetzbar
  - Zum Bohrfräsen geeignet
  - Zum Schruppen und Schlichten geeignet

- Applications – material (see page 5)**
- For wrought aluminium alloys
  - For aluminium alloys with a silicon content of up to 7%
  - With GLT coating also for copper alloys
  - Suitable for z-axis milling
  - Suitable for roughing and finishing

**GLT**

**N 1.1-1.3 1.4**

**N 1.1-1.4 2.1-2.7**

**DIN 6527 – Lange Ausführung · Long design**

**Eckenradius · Corner radius**

Bestell-Code · Order code										2546	2547	2546K	2547K
∅ d <sub>1</sub> h10	r ±0,02	l <sub>2</sub>	l <sub>3</sub>	l <sub>1</sub>	∅ d <sub>3</sub>	∅ d <sub>2</sub> h6	l <sub>A</sub>	Z (Flutes)	Dimens.- Code				
6	0,5	13	20	57	5,8	6	21	3	.006005	●	●	●	●
6	1	13	20	57	5,8	6	21	3	.006010	●	●	●	●
8	1	19	25	63	7,7	8	27	3	.008010	●	●	●	●
8	1,5	19	25	63	7,7	8	27	3	.008015	●	●	●	●
8	2	19	25	63	7,7	8	27	3	.008020	●	●	●	●
10	1	22	30	72	9,5	10	32	3	.010010	●	●	●	●
10	1,5	22	30	72	9,5	10	32	3	.010015	●	●	●	●
10	2	22	30	72	9,5	10	32	3	.010020	●	●	●	●
12	1	26	35	83	11,5	12	38	3	.012010	●	●	●	●
12	1,5	26	35	83	11,5	12	38	3	.012015	●	●	●	●
12	2	26	35	83	11,5	12	38	3	.012020	●	●	●	●
12	2,5	26	35	83	11,5	12	38	3	.012025	●	●	●	●
12	3	26	35	83	11,5	12	38	3	.012030	●	●	●	●
12	4	26	35	83	11,5	12	38	3	.012040	●	●	●	●
16	1	32	40	92	15,5	16	44	3	.016010	●	●	●	●
16	1,5	32	40	92	15,5	16	44	3	.016015	●	●	●	●
16	2	32	40	92	15,5	16	44	3	.016020	●	●	●	●
16	2,5	32	40	92	15,5	16	44	3	.016025	●	●	●	●
16	3	32	40	92	15,5	16	44	3	.016030	●	●	●	●
16	4	32	40	92	15,5	16	44	3	.016040	●	●	●	●
20	1	38	50	104	19,5	20	54	3	.020010	●	●	●	●
20	1,5	38	50	104	19,5	20	54	3	.020015	●	●	●	●
20	2	38	50	104	19,5	20	54	3	.020020	●	●	●	●
20	2,5	38	50	104	19,5	20	54	3	.020025	●	●	●	●
20	3	38	50	104	19,5	20	54	3	.020030	●	●	●	●
20	4	38	50	104	19,5	20	54	3	.020040	●	●	●	●

Andere Eckenradien auf Anfrage lieferbar  
Other corner radii available on request



**Hartmetall-Schaftfräser – lange Ausführung**  
Solid carbide end mills – long design

W

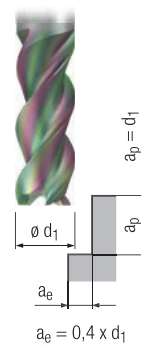
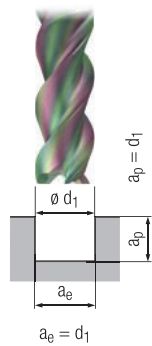

Gültig für · Valid for

- 2546
- 2546K
- 2547
- 2547K

**Achtung:**  
Bei unbeschichteter Ausführung ist die Schnittgeschwindigkeit  $v_c$  um 30% zu reduzieren!

**Please note:**  
For uncoated design, please reduce cutting speed  $v_c$  by 30%!



	$v_c$ [m/min]	$f_z$ [mm]	$v_c$ [m/min]	$f_z$ [mm]				
<b>Nichteisenwerkstoffe · Non-ferrous materials</b>								
<b>Aluminium-Legierungen · Aluminium alloys</b>								
1.1	300	$0,006 \times d_1$	420	$0,011 \times d_1$			□	■
1.2	430	$0,005 \times d_1$	620	$0,010 \times d_1$			□	■
1.3	385	$0,005 \times d_1$	550	$0,008 \times d_1$			□	■
1.4	270	$0,005 \times d_1$	380	$0,010 \times d_1$			□	■
1.5								
1.6								
<b>Kupfer-Legierungen · Copper alloys</b>								
2.1	100	$0,005 \times d_1$	160	$0,006 \times d_1$		□	□	■
2.2	100	$0,005 \times d_1$	160	$0,006 \times d_1$		□	□	■
2.3	100	$0,005 \times d_1$	160	$0,006 \times d_1$		□	□	■
2.4	80	$0,004 \times d_1$	140	$0,005 \times d_1$		□	□	■
2.5	80	$0,004 \times d_1$	140	$0,005 \times d_1$		□	□	■
2.6	80	$0,004 \times d_1$	140	$0,005 \times d_1$		□	□	■
2.7	60	$0,003 \times d_1$	100	$0,004 \times d_1$				■
2.8								
<b>Magnesium-Legierungen · Magnesium alloys</b>								
3.1								
3.2								
<b>Kunststoffe · Synthetics</b>								
4.1								
4.2								
4.3								
4.4								
<b>Besondere Werkstoffe · Special materials</b>								
5.1								
5.2								
5.3								

■ = sehr gut geeignet · very suitable  
□ = gut geeignet · suitable

$v_c$  = Schnittgeschwindigkeit · Cutting speed  
 $f_z$  = Vorschub pro Zahn · Feed per tooth

- Hochleistungswerkzeug
- Patentierte Querschnitte
- Scharfe Schneidkanten
- Sehr glatte CRN-Beschichtung
- 3 Baulängen verfügbar

- High performance tool
- Patented chisel edge
- Sharp cutting edges
- Very smooth CRN coating
- 3 lengths available

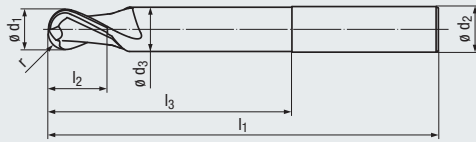
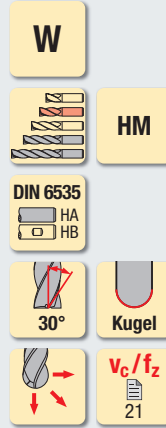

### Design I<sub>4</sub>:

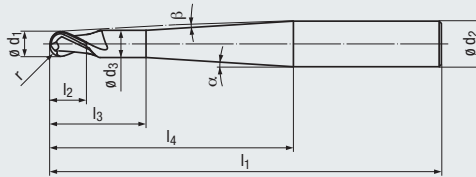

Al



Al/Cu

### Beschichtung · Coating

#### Einsatzgebiete – Material (siehe Seite 5)

- Für Aluminium-Knetlegierungen
- Für Aluminium-Legierungen mit einem Siliziumgehalt bis 7%
- Mit CRN-Beschichtung auch in Kupfer-Legierungen einsetzbar

#### Applications – material (see page 5)

- For wrought aluminium alloys
- For aluminium alloys with a silicon content of up to 7%
- With CRN coating also for copper alloys

N 1.1-1.3  
N 4.1-4.2 5.3

**CRN**  
N 1.1-1.4  
N 2.1-2.3 2.4-2.8  
N 3.1-4.4, 5.3

### Kurze Ausführung · Short design

#### Bestell-Code · Order code

$\phi d_1$ $\pm 0,01$	$r$ $\pm 0,005$	$l_2$	$l_3$	$l_1$	$\phi d_3$	$l_4$	$\phi d_2$ h5	$\alpha$	$\beta$	Z (Flutes)	Dimens.- Code	1921	1921R
0,5	0,25	1	2	38	0,45	9	3	10°	8°	2	.0005	●	●
0,5	0,25	1	2	57	0,45	20	6	10°	8,5°	2	.000506	●	●
1	0,5	2	4	38	0,95	9	3	12,5°	6,5°	2	.001	●	●
1	0,5	2	4	57	0,95	20	6	10°	8°	2	.00106	●	●
1,5	0,75	2,5	7,5	38	1,4	9	3	32°	5°	2	.0015	●	●
1,5	0,75	2,5	7,5	57	1,4	20	6	12,5°	7°	2	.001506	●	●
2	1	3	8	38	1,8	9	3	31°	3,5°	2	.002	●	●
2	1	3	8	57	1,8	20	6	12°	6,5°	2	.00206	●	●
3	1,5	3,5	10	57	2,8	20	6	11,5°	5°	2	.003	●	●
4	2	4	12	57	3,8	20	6	11°	3,5°	2	.004	●	●
5	2,5	5	14	57	4,7	20	6	10°	2°	2	.005	●	●
6	3	6	20	57	5,6	–	6	–	–	2	.006	●	●
8	4	7	25	63	7,6	–	8	–	–	2	.008	●	●
10	5	8	30	72	9,6	–	10	–	–	2	.010	●	●
12	6	10	35	83	11,5	–	12	–	–	2	.012	●	●



Werkzeug mit seitlicher Mitnahmefläche: Bestell-Code 1922/1922R  
Tool with side-lock clamping: order code 1922/1922R



**Hartmetall-Kugelfräser – kurze, lange und extra lange Ausführung**  
Solid carbide ball nose end mills – short, long and extra long design

W

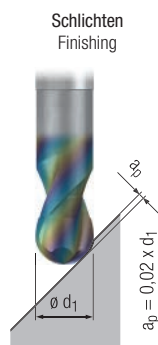
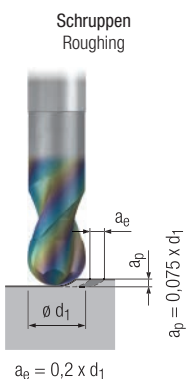

Gültig für · Valid for  
1921  
1921R

**Achtung:**  
Bei unbeschichteter Ausführung ist die Schnittgeschwindigkeit  $v_c$  um 30% zu reduzieren!

**Please note:**  
For uncoated design, please reduce cutting speed  $v_c$  by 30%!



	$v_c$ [m/min]	$f_z$ [mm]	$v_c$ [m/min]	$f_z$ [mm]				
<b>Nichteisenwerkstoffe · Non-ferrous materials</b>								
<b>Aluminium-Legierungen · Aluminium alloys</b>								
1.1	900	$0,022 \times d_1$	1200	$0,016 \times d_1$			<input type="checkbox"/>	<input checked="" type="checkbox"/>
1.2	900	$0,020 \times d_1$	1200	$0,014 \times d_1$			<input type="checkbox"/>	<input checked="" type="checkbox"/>
1.3	900	$0,017 \times d_1$	1200	$0,012 \times d_1$			<input type="checkbox"/>	<input checked="" type="checkbox"/>
1.4	600	$0,020 \times d_1$	800	$0,014 \times d_1$			<input type="checkbox"/>	<input checked="" type="checkbox"/>
1.5								
1.6								
<b>Kupfer-Legierungen · Copper alloys</b>								
2.1	200	$0,014 \times d_1$	260	$0,010 \times d_1$			<input type="checkbox"/>	<input checked="" type="checkbox"/>
2.2	200	$0,014 \times d_1$	260	$0,010 \times d_1$			<input type="checkbox"/>	<input checked="" type="checkbox"/>
2.3	200	$0,014 \times d_1$	260	$0,010 \times d_1$	<input type="checkbox"/>	<input type="checkbox"/>	<input type="checkbox"/>	<input checked="" type="checkbox"/>
2.4	160	$0,011 \times d_1$	220	$0,008 \times d_1$			<input type="checkbox"/>	<input checked="" type="checkbox"/>
2.5	160	$0,011 \times d_1$	220	$0,008 \times d_1$			<input type="checkbox"/>	<input checked="" type="checkbox"/>
2.6	160	$0,011 \times d_1$	220	$0,008 \times d_1$	<input type="checkbox"/>	<input type="checkbox"/>	<input type="checkbox"/>	<input checked="" type="checkbox"/>
2.7	100	$0,008 \times d_1$	140	$0,006 \times d_1$			<input type="checkbox"/>	<input checked="" type="checkbox"/>
2.8	100	$0,008 \times d_1$	140	$0,006 \times d_1$			<input type="checkbox"/>	<input checked="" type="checkbox"/>
<b>Magnesium-Legierungen · Magnesium alloys</b>								
3.1	450	$0,025 \times d_1$	600	$0,018 \times d_1$			<input type="checkbox"/>	<input checked="" type="checkbox"/>
3.2	450	$0,020 \times d_1$	600	$0,014 \times d_1$			<input type="checkbox"/>	<input checked="" type="checkbox"/>
<b>Kunststoffe · Synthetics</b>								
4.1	350	$0,021 \times d_1$	450	$0,015 \times d_1$		<input type="checkbox"/>	<input type="checkbox"/>	<input checked="" type="checkbox"/>
4.2	500	$0,021 \times d_1$	650	$0,015 \times d_1$		<input type="checkbox"/>	<input type="checkbox"/>	<input checked="" type="checkbox"/>
4.3	200	$0,017 \times d_1$	250	$0,012 \times d_1$		<input type="checkbox"/>	<input type="checkbox"/>	<input checked="" type="checkbox"/>
4.4	140	$0,017 \times d_1$	180	$0,012 \times d_1$		<input type="checkbox"/>	<input type="checkbox"/>	<input checked="" type="checkbox"/>
<b>Besondere Werkstoffe · Special materials</b>								
5.1								
5.2								
5.3	220	$0,017 \times d_1$	300	$0,012 \times d_1$	<input type="checkbox"/>	<input checked="" type="checkbox"/>		<input checked="" type="checkbox"/>

■ = sehr gut geeignet · very suitable  
□ = gut geeignet · suitable

$v_c$  = Schnittgeschwindigkeit · Cutting speed  
 $f_z$  = Vorschub pro Zahn · Feed per tooth

- Hochleistungswerkzeug
- Patentierte Querschnitte
- Scharfe Schneidkanten
- Sehr glatte CRN-Beschichtung
- 3 Baulängen verfügbar

- High performance tool
- Patented chisel edge
- Sharp cutting edges
- Very smooth CRN coating
- 3 lengths available

**W**

**HM**

**DIN 6535**  
HA  
HB

**30°**

**Kugel**

**$v_c / f_z$**   
23

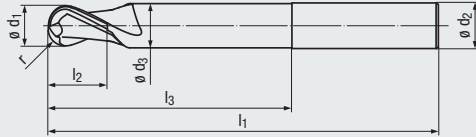

Design  $l_4$ :

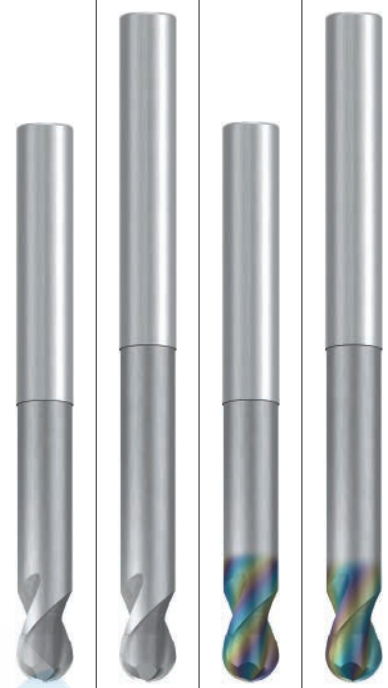
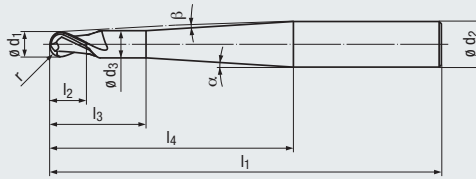

Al

Al/Cu

**Beschichtung · Coating**

**CRN**

**Einsatzgebiete – Material (siehe Seite 5)**

- Für Aluminium-Knetlegierungen
- Für Aluminium-Legierungen mit einem Siliziumgehalt bis 7%
- Mit CRN-Beschichtung auch in Kupfer-Legierungen einsetzbar

**Applications – material (see page 5)**

- For wrought aluminium alloys
- For aluminium alloys with a silicon content of up to 7%
- With CRN coating also for copper alloys

N	1.1-1.3	N	1.1-1.4
N	4.1-4.2	5.3	N 2.1-2.3
			2.4-2.8
			N 3.1-4.4, 5.3

**Lange Ausführung · Long design**

**Bestell-Code · Order code**

**2830**

**2830R**

$\phi d_1$ $\pm 0,01$	r $\pm 0,005$	$l_2$	$l_3$	$l_1$	$\phi d_3$	$l_4$	$\phi d_2$ h5	$\alpha$	$\beta$	Z (Flutes)	Dimens.- Code			
8	4	7	40	90	7,6	–	8	–	–	2	.008	●		●
10	5	8	50	100	9,6	–	10	–	–	2	.010	●		●
12	6	10	65	120	11,5	–	12	–	–	2	.012	●		●
16	8	12	80	140	15,5	–	16	–	–	2	.016	●		●

**Extra lange Ausführung · Extra long design**

**Bestell-Code · Order code**

**1943**

**1943R**

$\phi d_1$ $\pm 0,01$	r $\pm 0,005$	$l_2$	$l_3$	$l_1$	$\phi d_3$	$l_4$	$\phi d_2$ h5	$\alpha$	$\beta$	Z (Flutes)	Dimens.- Code			
3	1,5	3,5	12	80	2,8	40	6	3,5°	2,5°	2	.003	●		●
4	2	4	20	80	3,8	40	6	4°	1,5°	2	.004	●		●
5	2,5	5	10	100	4,7	40	6	1,5°	1°	2	.005	●		●
6	3	6	40	100	5,6	–	6	–	–	2	.006	●		●
8	4	7	60	120	7,6	–	8	–	–	2	.008	●		●
10	5	8	60	120	9,6	–	10	–	–	2	.010	●		●
12	6	10	70	160	11,5	–	12	–	–	2	.012	●		●



Werkzeug mit seitlicher Mitnahmefläche: Bestell-Code 2831/2831R (lange Ausführung) und 1843/1843R (extra lange Ausführung)  
Tool with side-lock clamping: order code 2831/2831R (long design) and 1843/1843R (extra long design)



**Hartmetall-Kugelfräser – kurze, lange und extra lange Ausführung**  
Solid carbide ball nose end mills – short, long and extra long design

W

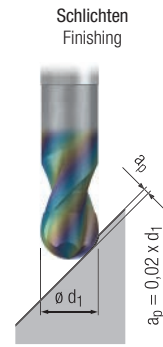
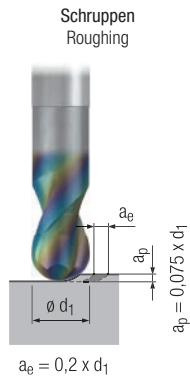

Gültig für · Valid for

- 1943
- 1943R
- 2830
- 2830R

**Achtung:**  
Bei unbeschichteter Ausführung ist die Schnittgeschwindigkeit  $v_c$  um 30% zu reduzieren!

**Please note:**  
For uncoated design, please reduce cutting speed  $v_c$  by 30%!



	$v_c$ [m/min]	$f_z$ [mm]	$v_c$ [m/min]	$f_z$ [mm]			MMS MQL	
<b>Nichteisenwerkstoffe · Non-ferrous materials</b>								
<b>Aluminium-Legierungen · Aluminium alloys</b>								
1.1	900	$0,022 \times d_1$	1200	$0,016 \times d_1$			<input type="checkbox"/>	<input checked="" type="checkbox"/>
1.2	900	$0,020 \times d_1$	1200	$0,014 \times d_1$			<input type="checkbox"/>	<input checked="" type="checkbox"/>
1.3	900	$0,017 \times d_1$	1200	$0,012 \times d_1$			<input type="checkbox"/>	<input checked="" type="checkbox"/>
1.4	600	$0,020 \times d_1$	800	$0,014 \times d_1$			<input type="checkbox"/>	<input checked="" type="checkbox"/>
1.5								
1.6								
<b>Kupfer-Legierungen · Copper alloys</b>								
2.1	200	$0,014 \times d_1$	260	$0,010 \times d_1$			<input type="checkbox"/>	<input checked="" type="checkbox"/>
2.2	200	$0,014 \times d_1$	260	$0,010 \times d_1$			<input type="checkbox"/>	<input checked="" type="checkbox"/>
2.3	200	$0,014 \times d_1$	260	$0,010 \times d_1$	<input type="checkbox"/>	<input type="checkbox"/>	<input type="checkbox"/>	<input checked="" type="checkbox"/>
2.4	160	$0,011 \times d_1$	220	$0,008 \times d_1$			<input type="checkbox"/>	<input checked="" type="checkbox"/>
2.5	160	$0,011 \times d_1$	220	$0,008 \times d_1$			<input type="checkbox"/>	<input checked="" type="checkbox"/>
2.6	160	$0,011 \times d_1$	220	$0,008 \times d_1$	<input type="checkbox"/>	<input type="checkbox"/>	<input type="checkbox"/>	<input checked="" type="checkbox"/>
2.7	100	$0,008 \times d_1$	140	$0,006 \times d_1$			<input type="checkbox"/>	<input checked="" type="checkbox"/>
2.8	100	$0,008 \times d_1$	140	$0,006 \times d_1$			<input type="checkbox"/>	<input checked="" type="checkbox"/>
<b>Magnesium-Legierungen · Magnesium alloys</b>								
3.1	450	$0,025 \times d_1$	600	$0,018 \times d_1$			<input type="checkbox"/>	<input checked="" type="checkbox"/>
3.2	450	$0,020 \times d_1$	600	$0,014 \times d_1$			<input type="checkbox"/>	<input checked="" type="checkbox"/>
<b>Kunststoffe · Synthetics</b>								
4.1	350	$0,021 \times d_1$	450	$0,015 \times d_1$		<input type="checkbox"/>	<input type="checkbox"/>	<input checked="" type="checkbox"/>
4.2	500	$0,021 \times d_1$	650	$0,015 \times d_1$		<input type="checkbox"/>	<input type="checkbox"/>	<input checked="" type="checkbox"/>
4.3	200	$0,017 \times d_1$	250	$0,012 \times d_1$		<input type="checkbox"/>	<input type="checkbox"/>	<input checked="" type="checkbox"/>
4.4	140	$0,017 \times d_1$	180	$0,012 \times d_1$		<input type="checkbox"/>	<input type="checkbox"/>	<input checked="" type="checkbox"/>
<b>Besondere Werkstoffe · Special materials</b>								
5.1								
5.2								
5.3	220	$0,017 \times d_1$	300	$0,012 \times d_1$	<input type="checkbox"/>	<input checked="" type="checkbox"/>		<input checked="" type="checkbox"/>

■ = sehr gut geeignet · very suitable  
□ = gut geeignet · suitable

$v_c$  = Schnittgeschwindigkeit · Cutting speed  
 $f_z$  = Vorschub pro Zahn · Feed per tooth

- Hochleistungswerkzeug
- Scharfe Schneidkanten
- Hochgenauer Eckenradius
- Sehr glatte CRN-Beschichtung
- 3 Baulängen verfügbar

- High performance tool
- Sharp cutting edges
- High-precision corner radius
- Very smooth CRN coating
- 3 lengths available

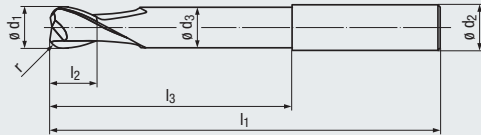
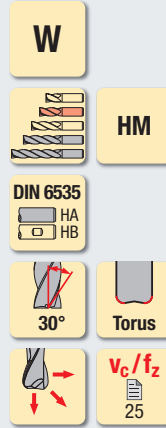

Design I<sub>4</sub>:

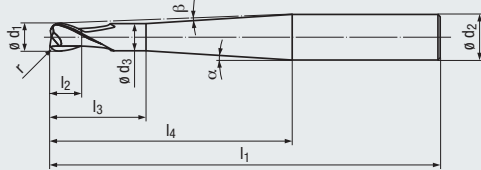

Al



Al/Cu

**Beschichtung · Coating**

**Einsatzgebiete – Material (siehe Seite 5)**

- Für Aluminium-Knetlegierungen
- Für Aluminium-Legierungen mit einem Siliziumgehalt bis 7%
- Mit CRN-Beschichtung auch in Kupfer-Legierungen einsetzbar

**Applications – material (see page 5)**

- For wrought aluminium alloys
- For aluminium alloys with a silicon content of up to 7%
- With CRN coating also for copper alloys

N	1.1-1.3	N	1.1-1.4
N	4.1-4.2	5.3	N 2.1-2.3 2.4-2.8
N	3.1-4.4, 5.3		

**Kurze Ausführung · Short design**

**Bestell-Code · Order code**

$\phi d_1$ $\pm 0,01$	r $\pm 0,005$	$l_2$	$l_3$	$l_1$	$\phi d_3$	$l_4$	$\phi d_2$ h5	$\alpha$	$\beta$	Z (Flutes)	Dimens.- Code	1942	1942R
0,5	0,1	1	2	38	0,45	9	3	10°	8°	2	.0005	●	●
0,5	0,1	1	2	57	0,45	20	6	10°	8,5°	2	.000506	●	●
1	0,25	2	4	38	0,95	9	3	12,5°	6,5°	2	.001	●	●
1	0,25	2	4	57	0,95	20	6	10°	8°	2	.00106	●	●
1,5	0,25	2,5	7,5	38	1,4	9	3	32°	5°	2	.0015	●	●
1,5	0,25	2,5	7,5	57	1,4	20	6	12,5°	7°	2	.001506	●	●
2	0,5	3	8	38	1,8	9	3	31°	3,5°	2	.002	●	●
2	0,5	3	8	57	1,8	20	6	12°	6,5°	2	.00206	●	●
3	0,5	3,5	10	57	2,8	20	6	11,5°	5°	2	.003	●	●
4	0,5	4	12	57	3,8	20	6	11°	3,5°	2	.004	●	●
5	0,5	5	14	57	4,7	20	6	10°	2°	2	.005	●	●
6	0,8	6	20	57	5,6	–	6	–	–	2	.006	●	●
8	1	7	25	63	7,6	–	8	–	–	2	.008	●	●
10	1	8	30	72	9,6	–	10	–	–	2	.010	●	●
12	1,5	10	35	83	11,5	–	12	–	–	2	.012	●	●



Werkzeug mit seitlicher Mitnahmefläche: Bestell-Code 1944/1944R  
Tool with side-lock clamping: order code 1944/1944R





**Hartmetall-Torusfräser – kurze, lange und extra lange Ausführung**  
Solid carbide torus end mills – short, long and extra long design

W

Schruppen  
Roughing

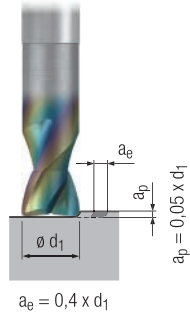

Schlichten  
Finishing

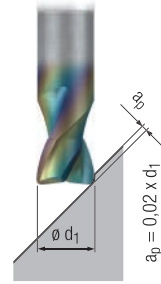

Gültig für · Valid for

1942  
1942R

**Achtung:**  
Bei unbeschichteter Ausführung ist die Schnittgeschwindigkeit  $v_c$  um 30% zu reduzieren!

**Please note:**  
For uncoated design, please reduce cutting speed  $v_c$  by 30%!



	$v_c$ [m/min]	$f_z$ [mm]	$v_c$ [m/min]	$f_z$ [mm]			MMS MQL	
<b>Nichteisenwerkstoffe · Non-ferrous materials</b>								
<b>Aluminium-Legierungen · Aluminium alloys</b>								
1.1	900	$0,022 \times d_1$	1200	$0,016 \times d_1$			<input type="checkbox"/>	<input checked="" type="checkbox"/>
1.2	900	$0,020 \times d_1$	1200	$0,014 \times d_1$			<input type="checkbox"/>	<input checked="" type="checkbox"/>
1.3	900	$0,017 \times d_1$	1200	$0,012 \times d_1$			<input type="checkbox"/>	<input checked="" type="checkbox"/>
1.4	600	$0,020 \times d_1$	800	$0,014 \times d_1$			<input type="checkbox"/>	<input checked="" type="checkbox"/>
1.5								
1.6								
<b>Kupfer-Legierungen · Copper alloys</b>								
2.1	200	$0,014 \times d_1$	260	$0,010 \times d_1$			<input type="checkbox"/>	<input checked="" type="checkbox"/>
2.2	200	$0,014 \times d_1$	260	$0,010 \times d_1$			<input type="checkbox"/>	<input checked="" type="checkbox"/>
2.3	200	$0,014 \times d_1$	260	$0,010 \times d_1$	<input type="checkbox"/>	<input type="checkbox"/>	<input type="checkbox"/>	<input checked="" type="checkbox"/>
2.4	160	$0,011 \times d_1$	220	$0,008 \times d_1$			<input type="checkbox"/>	<input checked="" type="checkbox"/>
2.5	160	$0,011 \times d_1$	220	$0,008 \times d_1$			<input type="checkbox"/>	<input checked="" type="checkbox"/>
2.6	160	$0,011 \times d_1$	220	$0,008 \times d_1$	<input type="checkbox"/>	<input type="checkbox"/>	<input type="checkbox"/>	<input checked="" type="checkbox"/>
2.7	100	$0,008 \times d_1$	140	$0,006 \times d_1$			<input type="checkbox"/>	<input checked="" type="checkbox"/>
2.8	100	$0,008 \times d_1$	140	$0,006 \times d_1$			<input type="checkbox"/>	<input checked="" type="checkbox"/>
<b>Magnesium-Legierungen · Magnesium alloys</b>								
3.1	450	$0,025 \times d_1$	600	$0,018 \times d_1$			<input type="checkbox"/>	<input checked="" type="checkbox"/>
3.2	450	$0,020 \times d_1$	600	$0,014 \times d_1$			<input type="checkbox"/>	<input checked="" type="checkbox"/>
<b>Kunststoffe · Synthetics</b>								
4.1	350	$0,021 \times d_1$	450	$0,015 \times d_1$		<input type="checkbox"/>	<input type="checkbox"/>	<input checked="" type="checkbox"/>
4.2	500	$0,021 \times d_1$	650	$0,015 \times d_1$		<input type="checkbox"/>	<input type="checkbox"/>	<input checked="" type="checkbox"/>
4.3	200	$0,017 \times d_1$	250	$0,012 \times d_1$		<input type="checkbox"/>	<input type="checkbox"/>	<input checked="" type="checkbox"/>
4.4	140	$0,017 \times d_1$	180	$0,012 \times d_1$		<input type="checkbox"/>	<input type="checkbox"/>	<input checked="" type="checkbox"/>
<b>Besondere Werkstoffe · Special materials</b>								
5.1								
5.2								
5.3	220	$0,017 \times d_1$	300	$0,012 \times d_1$	<input type="checkbox"/>	<input checked="" type="checkbox"/>		<input checked="" type="checkbox"/>

■ = sehr gut geeignet · very suitable  
□ = gut geeignet · suitable

$v_c$  = Schnittgeschwindigkeit · Cutting speed  
 $f_z$  = Vorschub pro Zahn · Feed per tooth

- Hochleistungswerkzeug
- Scharfe Schneidkanten
- Hochgenauer Eckenradius
- Sehr glatte CRN-Beschichtung
- 3 Baulängen verfügbar

- High performance tool
- Sharp cutting edges
- High-precision corner radius
- Very smooth CRN coating
- 3 lengths available

**W**

**HM**

**DIN 6535**  
HA  
HB

**30°**

**Torus**

**$v_c/f_z$**   
27

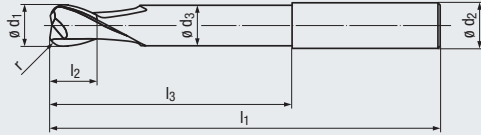

Design I<sub>4</sub>:

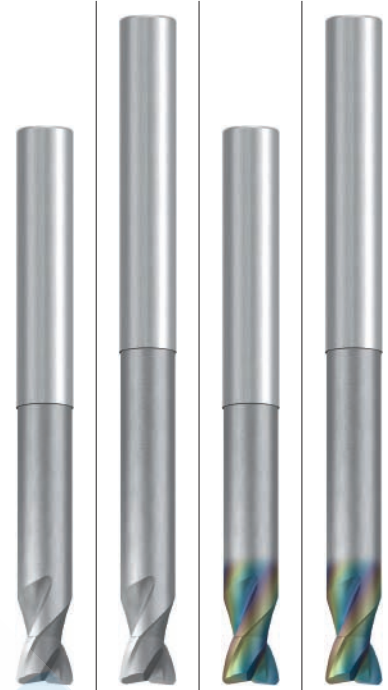
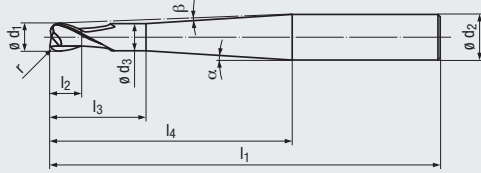

Al

Al/Cu

**Beschichtung · Coating**

**Einsatzgebiete – Material (siehe Seite 5)**

- Für Aluminium-Knetlegierungen
- Für Aluminium-Legierungen mit einem Siliziumgehalt bis 7%
- Mit CRN-Beschichtung auch in Kupfer-Legierungen einsetzbar

**Applications – material (see page 5)**

- For wrought aluminium alloys
- For aluminium alloys with a silicon content of up to 7%
- With CRN coating also for copper alloys

N	1.1-1.3	N	1.1-1.4
N	4.1-4.2	5.3	N 2.1-2.3
			2.4-2.8
			N 3.1-4.4, 5.3

**CRN**

**Lange Ausführung · Long design**

**Bestell-Code · Order code**

$\varnothing d_1$ $\pm 0,01$	r $\pm 0,005$	$l_2$	$l_3$	$l_1$	$\varnothing d_3$	$l_4$	$\varnothing d_2$ h5	$\alpha$	$\beta$	Z (Flutes)	Dimens.- Code	2838	2838R
8	1	7	40	90	7,6	–	8	–	–	2	.008	●	●
10	1	8	50	100	9,6	–	10	–	–	2	.010	●	●
12	1,5	10	65	120	11,5	–	12	–	–	2	.012	●	●
16	2	12	80	140	15,5	–	16	–	–	2	.016	●	●

**Extra lange Ausführung · Extra long design**

**Bestell-Code · Order code**

$\varnothing d_1$ $\pm 0,01$	r $\pm 0,005$	$l_2$	$l_3$	$l_1$	$\varnothing d_3$	$l_4$	$\varnothing d_2$ h5	$\alpha$	$\beta$	Z (Flutes)	Dimens.- Code	1941	1941R
3	0,5	3,5	12	80	2,8	40	6	3,5°	2,5°	2	.003	●	●
4	0,5	4	20	80	3,8	40	6	4°	1,5°	2	.004	●	●
5	0,5	5	10	100	4,7	40	6	1,5°	1°	2	.005	●	●
6	0,8	6	40	100	5,6	–	6	–	–	2	.006	●	●
8	1	7	60	120	7,6	–	8	–	–	2	.008	●	●
10	1	8	60	120	9,6	–	10	–	–	2	.010	●	●
12	1,5	10	70	160	11,5	–	12	–	–	2	.012	●	●



Werkzeug mit seitlicher Mitnahmefläche: Bestell-Code 2839/2839R (lange Ausführung) und 1841/1841R (extra lange Ausführung)  
Tool with side-lock clamping: order code 2839/2839R (long design) and 1841/1841R (extra long design)



**Hartmetall-Torusfräser – kurze, lange und extra lange Ausführung**  
Solid carbide torus end mills – short, long and extra long design

W

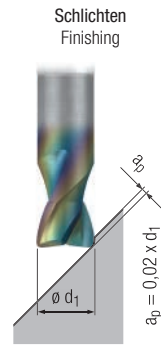
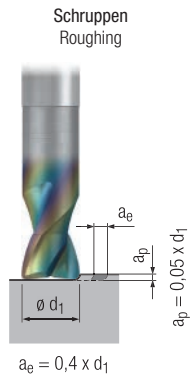

Gültig für · Valid for

- 1941
- 1941R
- 2838
- 2838R

**Achtung:**  
Bei unbeschichteter Ausführung ist die Schnittgeschwindigkeit  $v_c$  um 30% zu reduzieren!

**Please note:**  
For uncoated design, please reduce cutting speed  $v_c$  by 30%!



	$v_c$ [m/min]	$f_z$ [mm]	$v_c$ [m/min]	$f_z$ [mm]				
<b>Nichteisenwerkstoffe · Non-ferrous materials</b>								
<b>Aluminium-Legierungen · Aluminium alloys</b>								
1.1	900	$0,022 \times d_1$	1200	$0,016 \times d_1$			<input type="checkbox"/>	<input checked="" type="checkbox"/>
1.2	900	$0,020 \times d_1$	1200	$0,014 \times d_1$			<input type="checkbox"/>	<input checked="" type="checkbox"/>
1.3	900	$0,017 \times d_1$	1200	$0,012 \times d_1$			<input type="checkbox"/>	<input checked="" type="checkbox"/>
1.4	600	$0,020 \times d_1$	800	$0,014 \times d_1$			<input type="checkbox"/>	<input checked="" type="checkbox"/>
1.5								
1.6								
<b>Kupfer-Legierungen · Copper alloys</b>								
2.1	200	$0,014 \times d_1$	260	$0,010 \times d_1$			<input type="checkbox"/>	<input checked="" type="checkbox"/>
2.2	200	$0,014 \times d_1$	260	$0,010 \times d_1$			<input type="checkbox"/>	<input checked="" type="checkbox"/>
2.3	200	$0,014 \times d_1$	260	$0,010 \times d_1$	<input type="checkbox"/>	<input type="checkbox"/>	<input type="checkbox"/>	<input checked="" type="checkbox"/>
2.4	160	$0,011 \times d_1$	220	$0,008 \times d_1$			<input type="checkbox"/>	<input checked="" type="checkbox"/>
2.5	160	$0,011 \times d_1$	220	$0,008 \times d_1$			<input type="checkbox"/>	<input checked="" type="checkbox"/>
2.6	160	$0,011 \times d_1$	220	$0,008 \times d_1$	<input type="checkbox"/>	<input type="checkbox"/>	<input type="checkbox"/>	<input checked="" type="checkbox"/>
2.7	100	$0,008 \times d_1$	140	$0,006 \times d_1$			<input type="checkbox"/>	<input checked="" type="checkbox"/>
2.8	100	$0,008 \times d_1$	140	$0,006 \times d_1$			<input type="checkbox"/>	<input checked="" type="checkbox"/>
<b>Magnesium-Legierungen · Magnesium alloys</b>								
3.1	450	$0,025 \times d_1$	600	$0,018 \times d_1$			<input type="checkbox"/>	<input checked="" type="checkbox"/>
3.2	450	$0,020 \times d_1$	600	$0,014 \times d_1$			<input type="checkbox"/>	<input checked="" type="checkbox"/>
<b>Kunststoffe · Synthetics</b>								
4.1	350	$0,021 \times d_1$	450	$0,015 \times d_1$		<input type="checkbox"/>	<input type="checkbox"/>	<input checked="" type="checkbox"/>
4.2	500	$0,021 \times d_1$	650	$0,015 \times d_1$		<input type="checkbox"/>	<input type="checkbox"/>	<input checked="" type="checkbox"/>
4.3	200	$0,017 \times d_1$	250	$0,012 \times d_1$		<input type="checkbox"/>	<input type="checkbox"/>	<input checked="" type="checkbox"/>
4.4	140	$0,017 \times d_1$	180	$0,012 \times d_1$		<input type="checkbox"/>	<input type="checkbox"/>	<input checked="" type="checkbox"/>
<b>Besondere Werkstoffe · Special materials</b>								
5.1								
5.2								
5.3	220	$0,017 \times d_1$	300	$0,012 \times d_1$	<input type="checkbox"/>	<input checked="" type="checkbox"/>		<input checked="" type="checkbox"/>

■ = sehr gut geeignet · very suitable  
□ = gut geeignet · suitable

$v_c$  = Schnittgeschwindigkeit · Cutting speed  
 $f_z$  = Vorschub pro Zahn · Feed per tooth

- Hochleistungs-Schrupfräser mit groben, runden Spanteilern
- Erzeugt deutliche Oberflächenmarkierungen
- Neuentwickelte Geometrie
- Zentrumschneidend
- Vibrationsarme Bearbeitung
- Große Spanräume
- Innere Kühlschmierstoff-Zufuhr, Austritt radial und axial (ICRA)
- Sehr gute Spanabfuhr
- Lange Ausführung mit kurzer Schneidenlänge

- High-performance roughing end mill with coarse, round chip breakers
- Generates significant milling marks
- Newly developed geometry
- Centre cutting
- Low-vibration machining
- Large chip space
- Internal coolant supply, radial and axial exit (ICRA)
- Excellent chip evacuation
- Long design with short flute length

WR

grob  
coarse

ICRA

HSSE-  
PM

DIN 1835

40°

ER

V<sub>c</sub>/f<sub>z</sub>

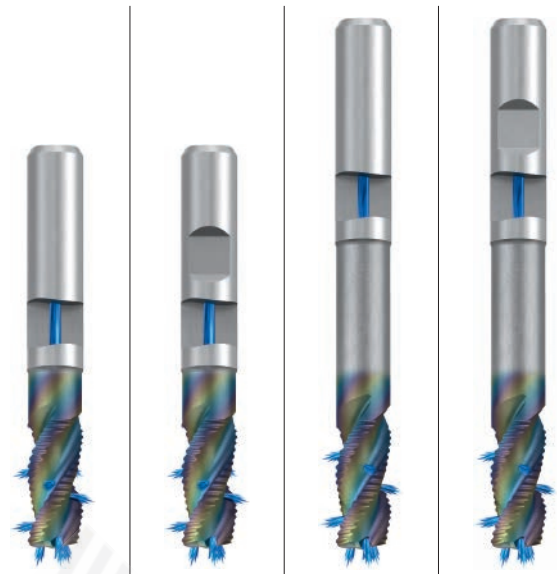
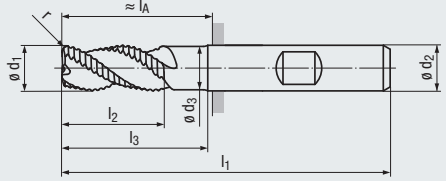

AI

AI

Beschichtung · Coating		<b>CRN</b>	<b>CRN</b>
Einsatzgebiete – Material (siehe Seite 5)		N 1.1-1.4 1.5	N 1.1-1.4 1.5
<ul style="list-style-type: none"> <li>- Sehr gut zum Schrumpfräsen von Leicht- und Buntmetallen mit einer Zugfestigkeit bis 500 N/mm<sup>2</sup></li> <li>- Besonders leistungsfähig beim Bohrfräsen, Nuten- und Taschenfräsen</li> <li>- Zur HPC-Bearbeitung geeignet</li> </ul>		N 2.1-2.6, 3.1-3.2	N 2.1-2.6, 3.1-3.2
Applications – material (see page 5)			
<ul style="list-style-type: none"> <li>- Very suitable for roughing light metals and non-ferrous metals with a tensile strength of up to 500 N/mm<sup>2</sup></li> <li>- Particularly effective for z-axis milling, slot milling and pocket milling</li> <li>- Suitable for HPC machining</li> </ul>			

DIN 844 – Kurze Ausführung · Short design										Eckenradius · Corner radius	
Bestell-Code · Order code										1092RZ	1392RZ
∅ d <sub>1</sub> k10	r	l <sub>2</sub>	l <sub>3</sub>	l <sub>1</sub>	∅ d <sub>3</sub>	∅ d <sub>2</sub> h6	l <sub>A</sub>	Z (Flutes)	Dimens.- Code		
16	2	32	42	92	14,5	16	44	3	.016020	●	●
16	4	32	42	92	14,5	16	44	3	.016040	●	●
20	2	38	52	104	18	20	54	3	.020020	●	●
20	4	38	52	104	18	20	54	3	.020040	●	●
25	2	45	63	121	23	25	65	3	.025020	●	●
25	4	45	63	121	23	25	65	3	.025040	●	●
32	2	53	70	133	30	32	73	3	.032020	●	●
32	4	53	70	133	30	32	73	3	.032040	●	●

Lange Ausführung · Long design										Eckenradius · Corner radius	
Bestell-Code · Order code										1093RZ	1393RZ
∅ d <sub>1</sub> k10	r	l <sub>2</sub>	l <sub>3</sub>	l <sub>1</sub>	∅ d <sub>3</sub>	∅ d <sub>2</sub> h6	l <sub>A</sub>	Z (Flutes)	Dimens.- Code		
16	2	32	73	123	14,5	16	75	3	.016020	●	●
16	4	32	73	123	14,5	16	75	3	.016040	●	●
20	2	38	89	141	18	20	91	3	.020020	●	●
20	4	38	89	141	18	20	91	3	.020040	●	●
25	2	45	108	166	23	25	110	3	.025020	●	●
25	4	45	108	166	23	25	110	3	.025040	●	●
32	2	53	123	186	30	32	126	3	.032020	●	●
32	4	53	123	186	30	32	126	3	.032040	●	●



**HSS-Schaftfräser – kurze und lange Ausführung**  
HSS end mills – short and long design

WR

Gültig für · Valid for

- 1092RZ
- 1093RZ
- 1392RZ
- 1393RZ

kurze Ausführung  
short design

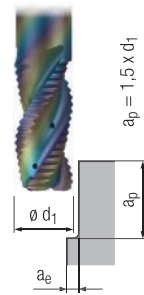
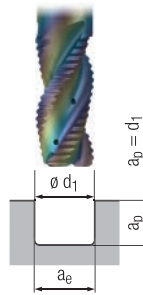

lange Ausführung  
long design

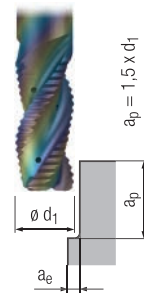

	$a_e = d_1$	$a_e = 0,5 \times d_1$	$a_e = 0,25 \times d_1$		$a_e = 0,5 \times d_1$	$a_e = 0,25 \times d_1$	$a_e = 0,1 \times d_1$
$V_C$ [m/min]	$f_z$ [mm]	$f_z$ [mm]	$f_z$ [mm]	$V_C$ [m/min]	$f_z$ [mm]	$f_z$ [mm]	$f_z$ [mm]



Nichteisenwerkstoffe · Non-ferrous materials												
Aluminium-Legierungen · Aluminium alloys												
1.1	360	$0,0048 \times d_1$	$0,0062 \times d_1$	$0,0077 \times d_1$	60	$0,0046 \times d_1$	$0,0053 \times d_1$	$0,0066 \times d_1$				■
1.2	320	$0,0045 \times d_1$	$0,0059 \times d_1$	$0,0072 \times d_1$	60	$0,0044 \times d_1$	$0,0050 \times d_1$	$0,0062 \times d_1$				■
1.3	250	$0,0042 \times d_1$	$0,0055 \times d_1$	$0,0067 \times d_1$	55	$0,0041 \times d_1$	$0,0046 \times d_1$	$0,0057 \times d_1$				■
1.4	200	$0,0039 \times d_1$	$0,0051 \times d_1$	$0,0062 \times d_1$	60	$0,0038 \times d_1$	$0,0043 \times d_1$	$0,0053 \times d_1$				■
1.5	150	$0,0036 \times d_1$	$0,0047 \times d_1$	$0,0058 \times d_1$	50	$0,0035 \times d_1$	$0,0040 \times d_1$	$0,0049 \times d_1$				■
1.6												
Kupfer-Legierungen · Copper alloys												
2.1	52	$0,0058 \times d_1$	$0,0047 \times d_1$	$0,0036 \times d_1$	30	$0,0049 \times d_1$	$0,0040 \times d_1$	$0,0035 \times d_1$			□	■
2.2	56	$0,0053 \times d_1$	$0,0043 \times d_1$	$0,0033 \times d_1$	34	$0,0045 \times d_1$	$0,0036 \times d_1$	$0,0032 \times d_1$			□	■
2.3	100	$0,0058 \times d_1$	$0,0047 \times d_1$	$0,0036 \times d_1$	48	$0,0049 \times d_1$	$0,0040 \times d_1$	$0,0035 \times d_1$			□	■
2.4	50	$0,0043 \times d_1$	$0,0035 \times d_1$	$0,0027 \times d_1$	32	$0,0037 \times d_1$	$0,0030 \times d_1$	$0,0026 \times d_1$			□	■
2.5	80	$0,0048 \times d_1$	$0,0039 \times d_1$	$0,0030 \times d_1$	48	$0,0041 \times d_1$	$0,0033 \times d_1$	$0,0029 \times d_1$			□	■
2.6	90	$0,0058 \times d_1$	$0,0047 \times d_1$	$0,0036 \times d_1$	48	$0,0049 \times d_1$	$0,0040 \times d_1$	$0,0035 \times d_1$			□	■
2.7												
2.8												
Magnesium-Legierungen · Magnesium alloys												
3.1	200	$0,0039 \times d_1$	$0,0051 \times d_1$	$0,0062 \times d_1$	70	$0,0038 \times d_1$	$0,0043 \times d_1$	$0,0053 \times d_1$	□	■		□
3.2	150	$0,0045 \times d_1$	$0,0059 \times d_1$	$0,0072 \times d_1$	70	$0,0044 \times d_1$	$0,0050 \times d_1$	$0,0062 \times d_1$	□	■		□
Kunststoffe · Synthetics												
4.1												
4.2												
4.3												
4.4												
Besondere Werkstoffe · Special materials												
5.1												
5.2												
5.3												

■ = sehr gut geeignet · very suitable  
□ = gut geeignet · suitable

$V_C$  = Schnittgeschwindigkeit · Cutting speed  
 $f_z$  = Vorschub pro Zahn · Feed per tooth

- Hochleistungs-Schlichtfräser
- Erzeugt glatte Oberflächen
- Neuentwickelte Geometrie mit ungleich geteilten Schneiden
- Zentrumschneidend
- Vibrationsarme Bearbeitung
- Große Spanräume
- Innere Kühlschmierstoff-Zufuhr, Austritt radial und axial (ICRA)
- Sehr gute Spanabfuhr
- Eingeschränkte Schneidendurchmesser-Toleranz

- High-performance finishing end mill
- Generates smooth surfaces
- Newly developed geometry with variable spacing of cutting edges
- Centre cutting
- Low-vibration machining
- Large chip space
- Internal coolant-lubricant supply, radial and axial exit (ICRA)
- Excellent chip evacuation
- Tighter cutting diameter tolerance

**W**

**ICRA**

**HSSE-PM**

**DIN 1835**

**40°**

**ER**

**v<sub>c</sub>/f<sub>z</sub> 31**

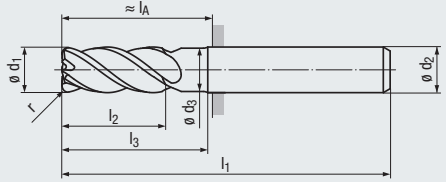

AI



AI

**Beschichtung · Coating**

**Einsatzgebiete – Material (siehe Seite 5)**

- Besonders zum Schlichtfräsen von Leicht- und Buntmetallen mit einer Zugfestigkeit bis 500 N/mm<sup>2</sup> geeignet

**Applications – material (see page 5)**

- Especially suitable for finishing light metals and non-ferrous metals with a tensile strength of up to 500 N/mm<sup>2</sup>

**CRN**

N	1.2-1.4	1.1, 1.5-1.6
N		3.1-4.2

**CRN**

N	1.2-1.4	1.1, 1.5-1.6
N		3.1-4.2

**DIN 844 – Kurze Ausführung · Short design**

**Eckenradius · Corner radius**

Bestell-Code · Order code									1034RZ		
ø d <sub>1</sub> h8	r ±0,1	l <sub>2</sub>	l <sub>3</sub>	l <sub>1</sub>	ø d <sub>3</sub>	ø d <sub>2</sub> h6	Z (Flutes)	Dimens.-Code			
16	2	32	42	92	14,5	16	4	.016020	●		
16	4	32	42	92	14,5	16	4	.016040	●		
20	2	38	52	104	18	20	4	.020020	●		
20	4	38	52	104	18	20	4	.020040	●		
25	2	45	63	121	23	25	4	.025020	●		
25	4	45	63	121	23	25	4	.025040	●		
32	2	53	70	133	30	32	4	.032020	●		
32	4	53	70	133	30	32	4	.032040	●		

**DIN 844 – Lange Ausführung · Long design**

**Eckenradius · Corner radius**

Bestell-Code · Order code											1035RZ	
ø d <sub>1</sub> h8	r ±0,1	l <sub>2</sub>	l <sub>3</sub>	l <sub>1</sub>	ø d <sub>3</sub>	ø d <sub>2</sub> h6	Z (Flutes)	Dimens.-Code				
16	2	63	73	123	14,5	16	4	.016020			●	
16	4	63	73	123	14,5	16	4	.016040			●	
20	2	75	89	141	18	20	4	.020020			●	
20	4	75	89	141	18	20	4	.020040			●	
25	2	90	108	166	23	25	4	.025020			●	
25	4	90	108	166	23	25	4	.025040			●	
32	2	106	123	186	30	32	4	.032020			●	
32	4	106	123	186	30	32	4	.032040			●	



**HSS-Schaftfräser – kurze und lange Ausführung**  
HSS end mills – short and long design

**W**

Gültig für · Valid for  
1034RZ  
1035RZ

kurze Ausführung  
short design

lange Ausführung  
long design

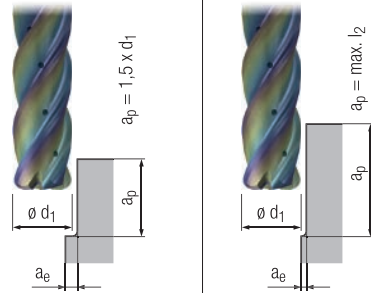
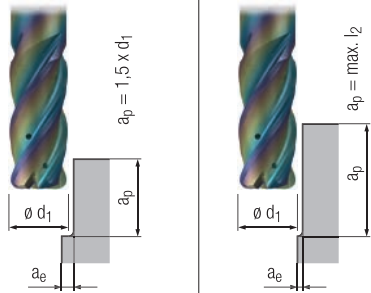

$V_C$ [m/min]	$f_z$ [mm]	$f_z$ [mm]	$f_z$ [mm]	$V_C$ [m/min]	$f_z$ [mm]	$f_z$ [mm]	$f_z$ [mm]
	$a_e = 0,25 \times d_1$	$a_e = 0,1 \times d_1$	$a_e = 0,2 \text{ mm}$		$a_e = 0,25 \times d_1$	$a_e = 0,1 \times d_1$	$a_e = 0,2 \text{ mm}$



Nichteisenwerkstoffe · Non-ferrous materials												
Aluminium-Legierungen · Aluminium alloys												
1.1	360	$0,0051 \times d_1$	$0,0070 \times d_1$	$0,0090 \times d_1$	60	$0,0038 \times d_1$	$0,0046 \times d_1$	$0,0064 \times d_1$				■
1.2	320	$0,0048 \times d_1$	$0,0066 \times d_1$	$0,0084 \times d_1$	60	$0,0036 \times d_1$	$0,0044 \times d_1$	$0,0060 \times d_1$				■
1.3	250	$0,0045 \times d_1$	$0,0062 \times d_1$	$0,0078 \times d_1$	55	$0,0034 \times d_1$	$0,0041 \times d_1$	$0,0056 \times d_1$				■
1.4	200	$0,0042 \times d_1$	$0,0057 \times d_1$	$0,0073 \times d_1$	60	$0,0031 \times d_1$	$0,0038 \times d_1$	$0,0052 \times d_1$				■
1.5	150	$0,0038 \times d_1$	$0,0053 \times d_1$	$0,0067 \times d_1$	50	$0,0029 \times d_1$	$0,0035 \times d_1$	$0,0048 \times d_1$				■
1.6	90	$0,0035 \times d_1$	$0,0048 \times d_1$	$0,0062 \times d_1$	40	$0,0026 \times d_1$	$0,0032 \times d_1$	$0,0044 \times d_1$				■
Kupfer-Legierungen · Copper alloys												
2.1												
2.2												
2.3												
2.4												
2.5												
2.6												
2.7												
2.8												
Magnesium-Legierungen · Magnesium alloys												
3.1	200	$0,0042 \times d_1$	$0,0057 \times d_1$	$0,0073 \times d_1$	100	$0,0048 \times d_1$	$0,0058 \times d_1$	$0,0080 \times d_1$	□	■		□
3.2	150	$0,0048 \times d_1$	$0,0066 \times d_1$	$0,0084 \times d_1$	180	$0,0048 \times d_1$	$0,0058 \times d_1$	$0,0080 \times d_1$	□	■		□
Kunststoffe · Synthetics												
4.1	200	$0,0042 \times d_1$	$0,0057 \times d_1$	$0,0073 \times d_1$	100	$0,0048 \times d_1$	$0,0058 \times d_1$	$0,0080 \times d_1$	□	□	□	■
4.2	150	$0,0048 \times d_1$	$0,0066 \times d_1$	$0,0084 \times d_1$	180	$0,0048 \times d_1$	$0,0058 \times d_1$	$0,0080 \times d_1$	□	□	□	■
4.3												
4.4												
Besondere Werkstoffe · Special materials												
5.1												
5.2												
5.3												

■ = sehr gut geeignet · very suitable  
□ = gut geeignet · suitable

$V_C$  = Schnittgeschwindigkeit · Cutting speed  
 $f_z$  = Vorschub pro Zahn · Feed per tooth

- Spanleitstufe 20° - Polierte Ausführung für optimalen Spanfluss - Chip former 20° - Polished design for optimum chip removal				HM	20°			AI	
<b>Schneidstoff · Cutting material</b>				KC2					
<b>Beschichtung · Coating</b>									
<b>Einsatzgebiete – Material (siehe Seite 5)</b> - Zum Schruppen und Schlichten von Aluminium-Knetlegierungen - Für die Volumenzerspanung		<b>Applications – material (see page 5)</b> - For roughing and finishing wrought aluminium alloys - For high-volume machining		N 1.1-1.3 2.1-4.2					
<b>Bestell-Code · Order code</b>				9635					
IC	R	b	Dimens.-Code						
4,6	0,5	2,2	.04605	●					
4,6	1	2,2	.04610	●					
9,2	2	3,6	.09220		●				
9,2	2,5	3,6	.09225			●			

- Spanleitstufe 20° - Sehr glatte CRN-Beschichtung - Chip former 20° - Very smooth CRN coating				HM	20°			Al/Cu	
<b>Schneidstoff · Cutting material</b>				KC2					
<b>Beschichtung · Coating</b>				CRN					
<b>Einsatzgebiete – Material (siehe Seite 5)</b> - Für Aluminium-Knetlegierungen - Für Aluminium-Legierungen mit einem Siliziumgehalt bis 7% - Für Kupfer-Legierungen - Zum Schruppen und Schlichten		<b>Applications – material (see page 5)</b> - For wrought aluminium alloys - For aluminium alloys with a silicon content of up to 7% - For copper alloys - For roughing and finishing		N 1.1-1.4 N 2.1-4.2 4.3-4.4 N 5.3					
<b>Bestell-Code · Order code</b>				9635R					
IC	R	b	Dimens.-Code						
4,6	0,5	2,2	.04605	●					
4,6	1	2,2	.04610	●					
9,2	2	3,6	.09220		●				
9,2	2,5	3,6	.09225			●			



Rhombische Wendeschneidplatten  
Rhombic inserts

Gültig für · Valid for  
9635  
9635R

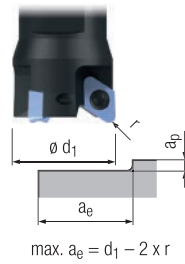

IC 4,6 / IC 9,2



9635

IC 4,6 / IC 9,2



9635R

	$v_c$ [m/min]	$f_z$ [mm]	$a_p$ [mm]	$v_c$ [m/min]	$f_z$ [mm]	$a_p$ [mm]			MMS MQL	
<b>Nichteisenwerkstoffe · Non-ferrous materials</b>										
<b>Aluminium-Legierungen · Aluminium alloys</b>										
1.1	800 - 1000	IC ÷ 30	0,10 - 0,20 x IC	800 - 1000	IC ÷ 30	0,10 - 0,20 x IC			<input type="checkbox"/>	<input checked="" type="checkbox"/>
1.2	800 - 1000	IC ÷ 30	0,10 - 0,20 x IC	800 - 1000	IC ÷ 30	0,10 - 0,20 x IC			<input type="checkbox"/>	<input checked="" type="checkbox"/>
1.3	600 - 800	IC ÷ 30	0,10 - 0,20 x IC	600 - 800	IC ÷ 30	0,10 - 0,20 x IC			<input type="checkbox"/>	<input checked="" type="checkbox"/>
1.4				400 - 600	IC ÷ 30	0,10 - 0,20 x IC			<input type="checkbox"/>	<input checked="" type="checkbox"/>
1.5										
1.6										
<b>Kupfer-Legierungen · Copper alloys</b>										
2.1	300 - 350	IC ÷ 60	0,05 - 0,10 x IC	300 - 350	IC ÷ 60	0,05 - 0,10 x IC	<input type="checkbox"/>	<input checked="" type="checkbox"/>	<input type="checkbox"/>	<input checked="" type="checkbox"/>
2.2	300 - 350	IC ÷ 60	0,05 - 0,10 x IC	300 - 350	IC ÷ 60	0,05 - 0,10 x IC	<input type="checkbox"/>	<input checked="" type="checkbox"/>	<input type="checkbox"/>	<input checked="" type="checkbox"/>
2.3	280 - 320	IC ÷ 60	0,05 - 0,10 x IC	280 - 320	IC ÷ 60	0,05 - 0,10 x IC	<input type="checkbox"/>	<input checked="" type="checkbox"/>	<input type="checkbox"/>	<input checked="" type="checkbox"/>
2.4	240 - 280	IC ÷ 60	0,05 - 0,10 x IC	240 - 280	IC ÷ 60	0,05 - 0,10 x IC	<input type="checkbox"/>	<input checked="" type="checkbox"/>	<input type="checkbox"/>	<input checked="" type="checkbox"/>
2.5	240 - 280	IC ÷ 60	0,05 - 0,10 x IC	240 - 280	IC ÷ 60	0,05 - 0,10 x IC	<input type="checkbox"/>	<input checked="" type="checkbox"/>	<input type="checkbox"/>	<input checked="" type="checkbox"/>
2.6	300 - 350	IC ÷ 60	0,05 - 0,10 x IC	300 - 350	IC ÷ 60	0,05 - 0,10 x IC	<input type="checkbox"/>	<input checked="" type="checkbox"/>	<input type="checkbox"/>	<input checked="" type="checkbox"/>
2.7	80 - 120	IC ÷ 60	0,05 - 0,10 x IC	80 - 120	IC ÷ 60	0,05 - 0,10 x IC			<input type="checkbox"/>	<input checked="" type="checkbox"/>
2.8	80 - 120	IC ÷ 60	0,05 - 0,10 x IC	80 - 120	IC ÷ 60	0,05 - 0,10 x IC			<input type="checkbox"/>	<input checked="" type="checkbox"/>
<b>Magnesium-Legierungen · Magnesium alloys</b>										
3.1	280 - 320	IC ÷ 30	0,05 - 0,10 x IC	280 - 320	IC ÷ 30	0,05 - 0,10 x IC			<input type="checkbox"/>	<input checked="" type="checkbox"/>
3.2	250 - 300	IC ÷ 30	0,05 - 0,10 x IC	250 - 300	IC ÷ 30	0,05 - 0,10 x IC			<input type="checkbox"/>	<input checked="" type="checkbox"/>
<b>Kunststoffe · Synthetics</b>										
4.1	200 - 240	IC ÷ 30	0,05 - 0,10 x IC	200 - 240	IC ÷ 30	0,05 - 0,10 x IC	<input checked="" type="checkbox"/>	<input type="checkbox"/>		<input type="checkbox"/>
4.2	80 - 120	IC ÷ 30	0,05 - 0,10 x IC	80 - 120	IC ÷ 30	0,05 - 0,10 x IC		<input type="checkbox"/>		<input checked="" type="checkbox"/>
4.3				100 - 140	IC ÷ 30	0,05 - 0,10 x IC	<input type="checkbox"/>	<input checked="" type="checkbox"/>		<input checked="" type="checkbox"/>
4.4				80 - 120	IC ÷ 30	0,05 - 0,10 x IC	<input type="checkbox"/>	<input checked="" type="checkbox"/>		<input checked="" type="checkbox"/>
<b>Besondere Werkstoffe · Special materials</b>										
5.1										
5.2										
5.3				100 - 140	IC ÷ 30	0,05 - 0,10 x IC				<input checked="" type="checkbox"/>

■ = sehr gut geeignet · very suitable  
□ = gut geeignet · suitable

$v_c$  = Schnittgeschwindigkeit · Cutting speed  
 $f_z$  = Vorschub pro Zahn · Feed per tooth

<ul style="list-style-type: none"> <li>- PKD-bestückt</li> <li>- Ohne Spanleitstufe</li> <li>- Mit scharfen Schneidkanten</li> </ul>		<ul style="list-style-type: none"> <li>- PCD-tipped</li> <li>- Without chip former</li> <li>- Sharp cutting edges</li> </ul>							
		<div style="display: flex; justify-content: space-around;"> <div style="border: 1px solid black; padding: 2px;">PKD</div> <div style="border: 1px solid black; padding: 2px;">0°</div> </div> <div style="display: flex; justify-content: space-around; margin-top: 5px;"> <div style="border: 1px solid black; padding: 2px;"> </div> <div style="border: 1px solid black; padding: 2px;"> <math>v_c/f_z</math> 35             </div> </div>				AI			
Schneidstoff · Cutting material				PKD					
Beschichtung · Coating									
Einsatzgebiete – Material (siehe Seite 5)		Applications – material (see page 5)							
<ul style="list-style-type: none"> <li>- Zum Schruppen und Schlichten von Aluminium-Legierungen mit einem Siliziumgehalt bis 17%</li> </ul>		<ul style="list-style-type: none"> <li>- For roughing and finishing aluminium alloys with a silicon content of up to 17%</li> </ul>				<div style="display: flex; justify-content: space-between;"> <div style="border: 1px solid black; padding: 2px;">N 1.5-1.6</div> <div style="border: 1px solid black; padding: 2px;">1.1-1.4</div> </div> <div style="display: flex; justify-content: space-between; margin-top: 2px;"> <div style="border: 1px solid black; padding: 2px;">N</div> <div style="border: 1px solid black; padding: 2px;">5.1, 5.3</div> </div>			
Bestell-Code · Order code				9679					
IC	R	b	Dimens.-Code						
4,6	1	2,2	.04610	●					
9,2	2	3,6	.09220		●				

Walter  
Cordbarlag  
für kontrollierte Späne

**Rhombische PKD-Wechselschneidplatten**  
Rhombic PCD inserts

Gültig für · Valid for  
9679

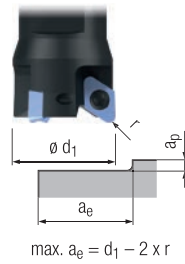

**IC 4,6 / IC 9,2**



9679



	$v_c$ [m/min]	$f_z$ [mm]	$a_p$ [mm]				
<b>Nichteisenwerkstoffe · Non-ferrous materials</b>							
<b>Aluminium-Legierungen · Aluminium alloys</b>							
1.1	800 - 1000	IC ÷ 30	0,10 - 0,20 x IC			<input type="checkbox"/>	<input checked="" type="checkbox"/>
1.2	800 - 1000	IC ÷ 30	0,10 - 0,20 x IC			<input type="checkbox"/>	<input checked="" type="checkbox"/>
1.3	600 - 800	IC ÷ 30	0,10 - 0,20 x IC			<input type="checkbox"/>	<input checked="" type="checkbox"/>
1.4	400 - 600	IC ÷ 30	0,10 - 0,20 x IC			<input type="checkbox"/>	<input checked="" type="checkbox"/>
1.5	400 - 600	IC ÷ 30	0,10 - 0,20 x IC			<input type="checkbox"/>	<input checked="" type="checkbox"/>
1.6	300 - 500	IC ÷ 30	0,10 - 0,20 x IC			<input type="checkbox"/>	<input checked="" type="checkbox"/>
<b>Kupfer-Legierungen · Copper alloys</b>							
2.1							
2.2							
2.3							
2.4							
2.5							
2.6							
2.7							
2.8							
<b>Magnesium-Legierungen · Magnesium alloys</b>							
3.1							
3.2							
<b>Kunststoffe · Synthetics</b>							
4.1							
4.2							
4.3							
4.4							
<b>Besondere Werkstoffe · Special materials</b>							
5.1	600 - 1000	IC ÷ 30	0,20 - 0,30 x IC				<input checked="" type="checkbox"/>
5.2							
5.3	200 - 300	IC ÷ 30	0,05 - 0,10 x IC				<input checked="" type="checkbox"/>

■ = sehr gut geeignet · very suitable  
□ = gut geeignet · suitable

$v_c$  = Schnittgeschwindigkeit · Cutting speed  
 $f_z$  = Vorschub pro Zahn · Feed per tooth

- Einschraubfräskörper
- Ab M8 innere Kühlschmierstoff-Zufuhr, Austritt radial (ICR)
- Mit 45° zum Fasfräsen geeignet
- Kompatibel zu marktüblichen Einschraub-Aufnahmen und Adaptern

- Indexable screw-in end mill
- From M8 internal coolant supply, radial exit (ICR)
- With 45° lead angle suitable for chamfering
- Compatible with commercially available screw-in holders and adapters

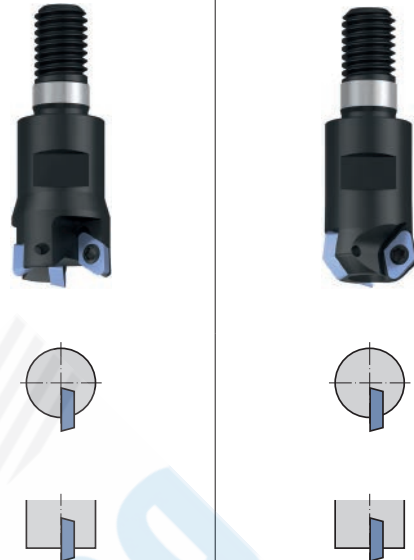
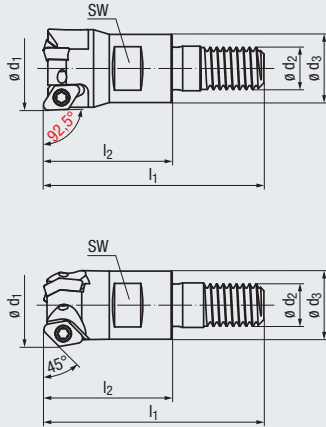
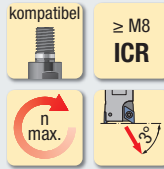

**IC 4,6**

Bestell-Code · Order code										9180	9181
$\varnothing d_1$	$l_2$	$l_1$	SW	$\varnothing d_3$	$\varnothing d_2$	$M_t$ max. ( $\varnothing d_2$ )	$n_{max}$ min <sup>-1</sup>	Z (Inserts)	Dimens.-Code		
10	20	35	8	10	M 6	8 Nm	40 000	2	.100202	●	
12	20	35	8	10	M 6	8 Nm	35 000	2	.120202	●	
16	25	43	10	13	M 8	15 Nm	28 000	3	.160253	●	●
20	32	52	15	18	M 10	30 Nm	25 000	3	.200323	●	

**IC 9,2**

Bestell-Code · Order code										9185	9186
$\varnothing d_1$	$l_2$	$l_1$	SW	$\varnothing d_3$	$\varnothing d_2$	$M_t$ max. ( $\varnothing d_2$ )	$n_{max}$ min <sup>-1</sup>	Z (Inserts)	Dimens.-Code		
20	32	52	15	18	M 10	30 Nm	35 000	2	.200322	●	
25	36	58	17	21	M 12	50 Nm	30 000	3	.250363	●	
32	40	64	22	29	M 16	100 Nm	25 000	3	.320403	●	●
40	40	64	22	29	M 16	100 Nm	22 000	4	.400424	●	

Lieferumfang: ohne Wendeschneidplatten, mit Torx-Schrauben  
 Delivery: without inserts, with Torx screws

Wendeschneidplatten siehe Seite 32 und 34  
 Inserts, see page 32 and 34

- Aufsteckfräskörper
- Innere Kühlschmierstoff-Zufuhr, Austritt radial (ICR)
- Indexable milling cutter
- Internal coolant supply, radial exit (ICR)

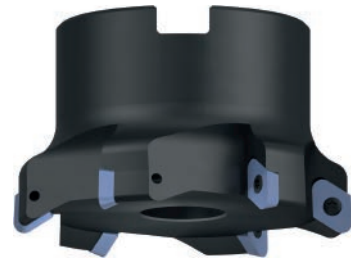
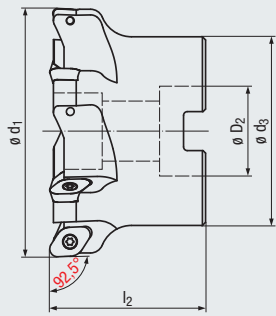
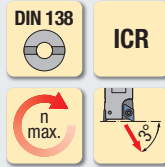

**IC 9,2**

Bestell-Code · Order code							9285
$\varnothing d_1$	$l_2$	$\varnothing d_3$	$\varnothing D_2$	$n_{max.}$ min <sup>-1</sup>	Z (Inserts)	Dimens.- Code	
50	50	40	22	22 000	5	.05005	●
63	50	50	27	20 000	6	.06306	●
80	50	60	27	18 000	6	.08006	●
100	56	78	32	15 000	7	.10007	●
125	65	90	40	12 000	8	.12508	●

Lieferumfang: ohne Wendeschneidplatten, mit Torx-Schrauben  
Delivery: without inserts, with Torx screws

Wendeschneidplatten siehe Seite 32 und 34  
Inserts, see page 32 and 34

**Zubehör · Accessories**

**Schraubendreher · Screwdriver**



Bestell-Code · Order code			9855
Größe Size	Dimens.- Code		
IC 4,6 Torx T7	.07	●	
IC 9,2 Torx T9	.09	●	

**Spannschraube · Clamping Screw**



Bestell-Code · Order code				9805
Größe Size	$M_d$ max.	Dimens.- Code		
IC 4,6 M2,2 x 3,7 x Torx T7	1 Nm	.223707	●	
IC 9,2 M3 x 6,5 x Torx T9	2,25 Nm	.306509	●	

**Hochtemperatur-Schraubenpaste · High-Temperature Screw Paste**



Bestell-Code · Order code			9000
Menge Quantity	Dimens.- Code		
100 g	.000	●	

Sicherstellung der Lösbarkeit von Torx-Schrauben für Wendeschneidplatten durch leichtes Einfetten von Gewinde und Senkkopf!

Applying a light coating of grease on thread and countersunk head ensures that the Torx screws for the inserts can be loosened again.

● = Lagerwerkzeug, siehe Preisliste · Stock tool, see price list  
○ = Kurzfristig lieferbar, Preis auf Anfrage · Available at short notice, price on request

- Eingelötete PKD-Schneiden
- Schwingungsgedämpft durch massiven Stahlgrundkörper
- hohe Wuchtgüte
- hohe Schneidanzahl ermöglicht hohe Vorschubwerte
- Kegel-Hohlschaft HSK-A nach DIN 69893-1
- Innere Kühlschmierstoff-Zufuhr, Austritt radial (ICR)

- PCD-tipped cutting edges
- Vibration absorbing due to solid steel base body
- High balance quality
- Large number of inserts enables high feed rates
- Hollow taper shank HSK-A acc. DIN 69893-1
- Internal coolant supply, axial exit (ICA)

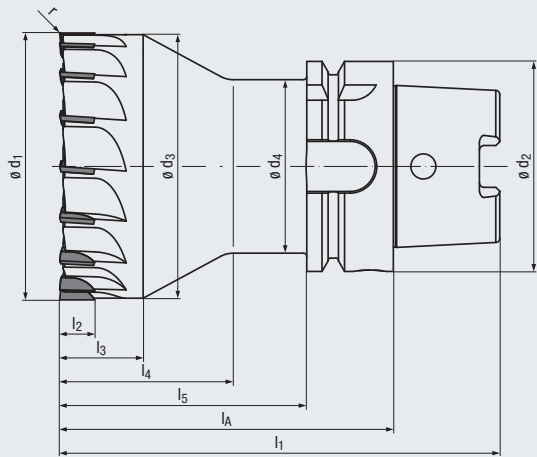

**N**

**ICR** **PKD**

**ER**

**n max.**

**1-3°**

**V<sub>c</sub>/f<sub>z</sub>**  
39



**AI**

**Einsatzgebiete – Material (siehe Seite 5)**

- Für Aluminium-Legierungen mit einem Siliziumgehalt bis 17%
- Auch für Verbundwerkstoffe und Grafitbearbeitung geeignet
- Zum HSC-Schruppen und -Schlichten geeignet
- Ermöglicht sehr hohe Oberflächengüten

**Applications – material (see page 5)**

- For aluminium alloys with a silicon content of up to 17%
- Also suitable for composites and graphite
- Suitable for HSC roughing and finishing
- Enables to achieve very high surface qualities

N	1.1-1.6	2.1-2.8
N	3.1-3.2	4.1-4.2
N	4.3-5.1, 5.3	5.2

**Monoblock-Ausführung · Monobloc design**

Bestell-Code · Order code													2885_Z	
∅ d <sub>1</sub>	r	l <sub>2</sub>	l <sub>1</sub>	∅ d <sub>3</sub>	l <sub>3</sub>	∅ d <sub>4</sub>	l <sub>4</sub>	l <sub>5</sub>	∅ d <sub>2</sub>	l <sub>A</sub>	n <sub>max.</sub> <sup>2)</sup> min <sup>-1</sup>	Z (Flutes)	Dimens.- Code	
<b>32</b>	0,2	10	132	31	50	52	60	74	HSK-A63	100	25 000	<b>8</b>	<b>.032</b>	●
<b>40</b>	0,2	10	132	39	50	52	60	74	HSK-A63	100	25 000	<b>10</b>	<b>.040</b>	●
<b>50</b>	0,2	10	132	49	50	52	60	74	HSK-A63	100	25 000	<b>12</b>	<b>.050</b>	●
<b>63</b>	0,2	10	132	62	25	52	51	74	HSK-A63	100	25 000	<b>14</b>	<b>.063</b>	●
<b>80</b>	0,2	10	132	79	25	52	52	74	HSK-A63	100	25 000	<b>16</b>	<b>.080</b>	●
<b>100</b>	0,2	10	132	99	22	52	40	74	HSK-A63	100	25 000	<b>18</b>	<b>.100</b>	●
<b>125</b>	0,2	10	132	124	22	52	41	74	HSK-A63	100	20 000	<b>22</b>	<b>.125</b>	●
<b>160</b>	0,2	10	132	159	22	52	41	74	HSK-A63	100	15 000	<b>28</b>	<b>.160</b>	●

2) Maximal zulässige Drehzahl  
Maximum permissible revolution

Auf Anfrage auch mit anderen Schaftausführungen lieferbar  
Other shank designs available on request

Auf Anfrage auch mit reduzierter Zähnezahl lieferbar  
Also available with a reduced number of inserts on request

PKD-Plan- und Eckfräser  
PCD side and face milling cutters

N

Gültig für · Valid for  
2885\_Z

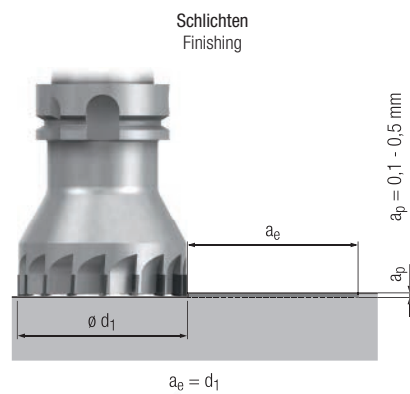
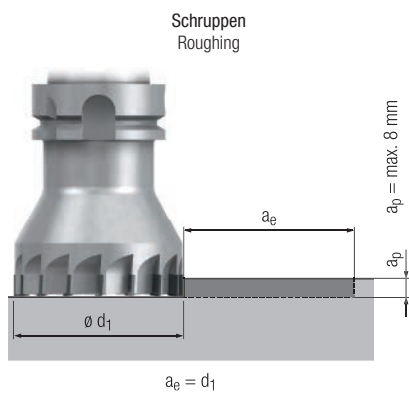

		$V_c$ [m/min]	$f_z$ [mm]	$V_c$ [m/min]	$f_z$ [mm]			MMS MQL		
<b>Nichteisenwerkstoffe · Non-ferrous materials</b>										
<b>Aluminium-Legierungen · Aluminium alloys</b>										
N	1.1	2500 - 5000	0,08 - 0,12	2500 - 5000	0,03 - 0,12		■	□	■	
	1.2	2500 - 5000	0,08 - 0,12	2500 - 5000	0,03 - 0,12		■	□	■	
	1.3	2500 - 5000	0,08 - 0,12	2500 - 5000	0,03 - 0,12		■	□	■	
	1.4	2500 - 5000	0,08 - 0,12	2500 - 5000	0,03 - 0,12		■	□	■	
	1.5	2500 - 5000	0,08 - 0,12	2500 - 5000	0,03 - 0,12		■	□	■	
	1.6	1000 - 2000	0,08 - 0,12	1000 - 2000	0,03 - 0,12		■	□	■	
	<b>Kupfer-Legierungen · Copper alloys</b>									
	2.1	1000 - 2000	0,08 - 0,12	1000 - 2000	0,03 - 0,08			□	■	
	2.2	1000 - 2000	0,08 - 0,12	1000 - 2000	0,03 - 0,08			□	■	
	2.3	1000 - 2000	0,08 - 0,12	1000 - 2000	0,03 - 0,08			□	■	
	2.4	1000 - 2000	0,08 - 0,12	1000 - 2000	0,03 - 0,08			□	■	
	2.5	1000 - 2000	0,08 - 0,12	1000 - 2000	0,03 - 0,08			□	■	
	2.6	1000 - 2000	0,08 - 0,12	1000 - 2000	0,03 - 0,08			□	■	
	2.7	1000 - 2000	0,08 - 0,12	1000 - 2000	0,03 - 0,08			□	■	
	2.8	1000 - 2000	0,08 - 0,12	1000 - 2000	0,03 - 0,08			□	■	
	<b>Magnesium-Legierungen · Magnesium alloys</b>									
3.1	2500 - 5000	0,08 - 0,12	2500 - 5000	0,03 - 0,08			□	■		
3.2	2500 - 5000	0,08 - 0,12	2500 - 5000	0,03 - 0,08			□	■		
<b>Kunststoffe · Synthetics</b>										
4.1	1500 - 3000	0,08 - 0,12	1500 - 3000	0,03 - 0,08			□	■		
4.2	1500 - 3000	0,08 - 0,12	1500 - 3000	0,03 - 0,08			□	■		
4.3	1500 - 3000	0,08 - 0,12	1500 - 3000	0,03 - 0,08			□	■		
4.4	1500 - 3000	0,08 - 0,12	1500 - 3000	0,03 - 0,08			□	■		
<b>Besondere Werkstoffe · Special materials</b>										
5.1	1000 - 2000	0,08 - 0,12	1000 - 2000	0,03 - 0,08			□	■		
5.2	1000 - 2000	0,08 - 0,12	1000 - 2000	0,03 - 0,08			□	■		
5.3	1000 - 2000	0,08 - 0,12	1000 - 2000	0,03 - 0,08			□	■		

■ = sehr gut geeignet · very suitable  
□ = gut geeignet · suitable

$V_c$  = Schnittgeschwindigkeit · Cutting speed  
 $f_z$  = Vorschub pro Zahn · Feed per tooth

**Bearbeitungsbeispiel**
**Machining example**
**Maschine:**

DMC 80 U duoBLOCK®

**Spindel:**

 12.000 min<sup>-1</sup>

130 Nm

SK 40

Kühlschmierstoff-Druck 40 bar

Emulsion 12%

**Material:**

Aluminiumlegierung

AlMg4,5Mn - F27

EN AW 5083

**Machine:**

DMC 80 U duoBLOCK®

**Spindle:**

12 000 rpm

130 Nm

ISO 40

Coolant-lubricant pressure 40 bar

Emulsion 12%

**Material:**

Aluminium alloy

AlMg4,5Mn - F27

EN AW 5083

**Zielsetzung:**

Reduzieren der Fertigungszeit durch Optimierung der Schruppoperation an einem Strukturbauteil für die Luftfahrtindustrie.

**Lösung:**

Austausch des herkömmlichen Werkzeuges durch den FRANKEN Alu-Cut Hartmetall-Schaftfräser „Aerospace“ Typ WR, ø 20 mm (Art.-Nr. 2888\_Z.020). Dadurch erfolgte nach einer Optimierung der Schnittdaten und Eingriffsverhältnisse eine Verdreifachung des Zeitspanvolumens.

**Objective:**

Reducing production time by optimizing the roughing operation on a structural component for the aircraft industry.

**Solution:**

Replacing the conventional tool by the FRANKEN Alu-Cut solid carbide end mill “Aerospace” type WR, dia. 20 mm (art. no. 2888\_Z.020). After optimizing the cutting data and the depth-of-cut values, the metal removal rate could be tripled.



		Schnittdaten Cutting data	
		herkömmlich conventional	FRANKEN Alu-Cut „Aerospace“
Schnittgeschwindigkeit / Cutting speed	$v_c$ [m/min]	500	630
Drehzahl / Speed/rpm	$n$ [min <sup>-1</sup> ]	7 960	10 000
Vorschub pro Zahn / Feed per tooth	$f_z$ [mm]	0,175	0,23
Vorschub eff. / Feed eff.	$v_f$ [mm/min]	5 570	6 900
Axiale Zustellung / Axial depth-of-cut	$a_p$ [mm]	8	20
Radiale Zustellung / Radial depth-of-cut	$a_e$ [mm]	10-20	10-20
Spanvolumen / Machining volume	$Q$ [l/min]	<b>0,67</b>	<b>2,07</b>



## Bearbeitungsbeispiel

## Machining example

**Maschine:**

Alzmetall GS 1000 5T

**Spindel:**

18 000 min<sup>-1</sup>  
138 Nm  
HSK-A63  
Kühlschmierstoff-Druck 40 bar  
Emulsion 10%

**Material:**

Aluminiumlegierung  
AlZnMgCu1,5 - F53  
EN AW 7075



**Machine:**

Alzmetall GS 1000 5T

**Spindle:**

18 000 rpm  
138 Nm  
HSK-A63  
Coolant-lubricant pressure 40 bar  
Emulsion 10%

**Material:**

Aluminium alloy  
AlZnMgCu1.5 - F53  
EN AW 7075

**Zielsetzung:**

Reduzierung der Bearbeitungszeit bei einem Integralbauteil für die Luftfahrtindustrie.

**Lösung:**

Austausch des herkömmlichen Werkzeuges durch den FRANKEN Alu-Cut Hartmetall-Schaftfräser „Aerospace“ Typ WR, ø 20 mm mit Eckenradius 2 mm (Art.-Nr. 2890\_Z.020020).

Nach einer Optimierung der Schnittdaten und Eingriffsverhältnisse konnte das Zeitspanvolumen fast versechsfacht werden. Die Standzeit des Alu-Cut „Aerospace“ lag gegenüber dem konventionellen Werkzeug um ca. 75% höher.

**Objective:**





Reducing the machining time for an integral component for the aircraft industry.





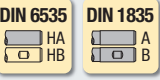

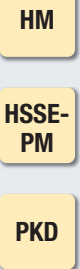
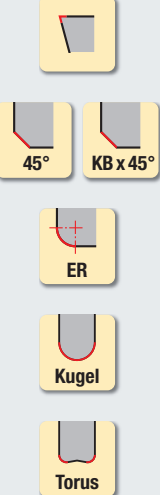

**Solution:**

Replacing the conventional tool by the FRANKEN Alu-Cut solid carbide end mill “Aerospace” type WR, dia 20 mm with corner radius 2 mm (art. no. 2890\_Z.020020). After optimizing cutting data and depth-of-cut values, the metal removal rates could be increased to almost six times the former volume. The tool life of the Alu-Cut “Aerospace” was approximately 75% higher than that of the conventional tool.

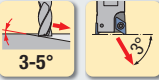

		Schnittdaten Cutting data	
		herkömmlich conventional	FRANKEN Alu-Cut „Aerospace“
Schnittgeschwindigkeit / Cutting speed	$v_c$ [m/min]	300	578
Drehzahl / Speed/rpm	$n$ [min <sup>-1</sup> ]	4780	9200
Vorschub pro Zahn / Feed per tooth	$f_z$ [mm]	0,10	0,20
Vorschub eff. / Feed eff.	$v_f$ [mm/min]	1912	5520
Axiale Zustellung / Axial depth-of-cut	$a_p$ [mm]	10	20
Radiale Zustellung / Radial depth-of-cut	$a_e$ [mm]	20	20
Spanvolumen / Machining volume	$Q$ [l/min]	<b>0,38</b>	<b>2,21</b>

	<p><b>Baulänge</b></p> <p>extra kurz kurz mittellang lang extra lang</p> <p>Die entsprechende Baulänge ist rot hervorgehoben. Alternativ-Baulängen des gleichen Typs sind grau unterlegt. Nicht gekennzeichnete Baulängen sind im Lieferprogramm nicht enthalten.</p>	<p><b>Constructional length</b></p> <p>extra short short medium length long extra long</p> <p>The relevant length is marked in red. Alternative lengths of the same type are marked in grey. Lengths without any marking are not available as catalogue products.</p>
	<p><b>Schaftausführung</b></p> <p>Die auf der jeweiligen Seite befindlichen Schaftausführungen sind grau unterlegt.</p>	<p><b>Shank design</b></p> <p>The shank designs to be found on the respective page are marked in grey.</p>
	<p><b>Einschraubgewinde</b></p> <p>Das Einschraubgewinde dieser Fräser ist kompatibel zu marktüblichen Einschraub-Aufnahmen und Adaptern.</p>	<p><b>Screw-in thread</b></p> <p>The screw-in thread of these end mills is compatible with commercially available screw-in holders and adapters.</p>
	<p><b>Bohrungsausführung</b></p> <p>Zylindrische Bohrung mit Quernut</p>	<p><b>Bore design</b></p> <p>Straight bore with driving slot</p>
	<p><b>Drallwinkel</b></p> <p>Angegeben ist der Drallwinkel dieser Werkzeuge. Bei unterschiedlichen Drallwinkeln sind alle Winkel aufgeführt.</p>	<p><b>Helix angle</b></p> <p>The helix angle of these tools is shown. If there are variable helix angles, these are all shown.</p>
	<p><b>Spanteiler</b></p> <p>Diese Fräser erzeugen entsprechende Oberflächenmarkierungen.</p>	<p><b>Chip breaker</b></p> <p>These end mills generate appropriate milling marks.</p>
	<p><b>Schneidstoff</b></p> <p>Hartmetall</p> <p>Pulvermetallurgischer Hochleistungs-Schnellarbeitsstahl</p> <p>Polykristalliner Diamant</p>	<p><b>Cutting material</b></p> <p>Solid carbide</p> <p>Powder metal high speed steel</p> <p>Polycrystalline diamond</p>
	<p><b>Schneideckenausführung und Stirnkontur</b></p> <p>Scharfkantig</p> <p>Schutzeckenfase (Kantenbruch)</p> <p>Eckenradius</p> <p>Kugel (Vollradius)</p> <p>Torus</p>	<p><b>Cutting edge design and face geometry</b></p> <p>Sharp-edged</p> <p>Bevelled edge</p> <p>Corner radius</p> <p>Ball nose</p> <p>Torus</p>

	<b>Innere Kühlschmierstoff-Zufuhr</b>	<b>Internal coolant supply</b>
	ICR = Kühlschmierstoffaustritt radial	ICR = Internal coolant supply, radial exit
	ICRA = Kühlschmierstoffaustritt radial und axial	ICRA = Internal coolant supply, radial and axial exit
<hr/>		
	<b>Kühlung und Schmierung</b>	<b>Coolant and lubrication</b>
	Trockenbearbeitung	Dry machining
	Kaltluftdüse	Cold-air nozzle
	Minimalmengenschmierung (MMS)	Minimum-quantity lubrication (MQL)
	Emulsion	Emulsion
<hr/>		
	<b>Vorschubrichtung</b>	<b>Feed direction</b>
	Die roten Pfeile beschreiben die empfohlenen Vorschubrichtungen der abgebildeten Fräser.	The red arrows mark the recommended feed directions of the respective cutters.
<hr/>		
	<b>Rampenwinkel</b>	<b>Ramping angle</b>
	Der Rampenwinkel ist der empfohlene Winkel beim Eintauchen in das Werkstück.	The specified angle is the recommended angle for ramping applications.
<hr/>		
	<b>Maximal zulässige Drehzahl</b>	<b>Maximum permissible revolution</b>
	Die max. zulässige Drehzahl des Fräskörpers in Verbindung mit Wendeschneidplatten ist ein Sicherheitswert und darf keinesfalls überschritten werden.	The maximum permissible revolution of an indexable milling cutter is a safety value, please not to be exceeded.
	<b>Dieser Wert ist keine Schnittwertangabe!</b>	<b>Do not use this value as cutting condition recommendation!</b>

## Walter Cordbarlag GmbH & Co. KG

🏠 Am Poggenpohl 6  
33619 Bielefeld

☎ +49 521.492751  
📠 +49 521.493756

✉ info@cordbarlag.de  
🌐 www.cordbarlag.de

