

ZGF

EMUGE

Zirkular-Gewindefräser für kleine Gewindeabmessungen
Circular Thread Milling Cutters for Small Thread Sizes

Die Zirkular-Gewindefräser der Typenreihe ZGF sind besonders für problematische Einsatzstellen im kleinen Gewindebereich geeignet. Die Ausführung ZGF – 2 x D wurde für den universellen Einsatz entwickelt, mit den Ausführungen ZGF – 3 x D und ZGF – 4 x D lassen sich darüber hinaus große Gewindetiefen realisieren.

Mit dem Zirkular-Gewindefräser ZGF-Z ist dank seiner optimierten Schneidengeometrie und einer hohen Nutenzahl eine schnellere Bearbeitung der Bauteile möglich.

Zirkular-Gewindefräser vom Typ ZGF-S-CUT sind für den Einsatz in schwer zerspanbaren Materialien ausgelegt, mit dem ZGF-HCUT lassen sich harte Werkstoffe bearbeiten.

The circular thread milling cutters of the ZGF type series are particularly suitable for difficult machining operations with smaller thread sizes. The ZGF – 2 x D version was developed for universal use, and the ZGF – 3 x D and ZGF – 4 x D versions can also be used for large thread depths.

The circular thread milling cutter ZGF-Z enables faster machining of components thanks to its optimised cutting geometry and a high number of grooves.

The circular thread milling cutters type ZGF-S-CUT are designed for use in materials that are difficult to machine, and the ZGF-HCUT is used for hard materials.



Die Vorteile der Zirkular-Gewindefräser

- Hohe Prozesssicherheit
- Geringe Schnittkräfte
- Kein axial verschnittenes Gewinde
- Hohe Oberflächenqualität der Gewinde
- Grundlochbearbeitung bis zum Bohrungsgrund möglich
- Hohe Positioniergenauigkeit
- Für Rechts- und Linksgewinde geeignet

Advantages of circular thread milling cutters

- High process safety
- Low cutting forces
- No axial miscut threads
- High surface quality of the threads
- Threads can be cut down to the bottom of the hole
- High positioning precision
- Suitable for right-hand and left-hand threads

Verfügbar in den gängigsten Abmessungen der Gewinnesysteme

Available in the most common dimensions of thread systems

Metrisches ISO-Regelgewinde DIN 13	M	ISO Metric coarse thread DIN 13
Metrisches ISO-Feingewinde DIN 13	MF	ISO Metric fine thread DIN 13
Unified-Gewinde ANSI B1.1	UN	Unified thread ANSI B1.1
Unified-Grobgewinde ASME B1.1	UNC	Unified coarse thread ASME B1.1
Unified-Feingewinde ASME B1.1	UNF	Unified fine thread ASME B1.1
Whitworth-Rohrgewinde DIN EN ISO 228	G (BSP)	Whitworth pipe thread DIN EN ISO 228

Geeignet zum Einsatz in den Materialgruppen

Suitable for use in the material groups

Stahlwerkstoffe	P	Steel materials
Nichtrostende Stahlwerkstoffe	M	Stainless steel materials
Gusswerkstoffe	K	Cast materials
Nichteisenwerkstoffe	N	Non ferrous materials
Spezialwerkstoffe	S	Special materials
Harte Werkstoffe	H	Hard materials

ZGF

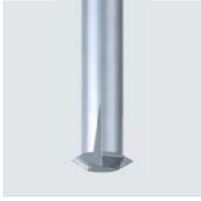

Zirkular-Gewindefräser

- Für die Herstellung von Gewinden ab M 1
- Mit korrigiertem Gewindeprofil
- Abmessungsübergreifend
- Steigungsübergreifend

Circular thread milling cutters

- For the machining of threads from M 1
- With corrected thread profile
- For different thread sizes
- For different pitches

ZGF-Z



Zirkular-Gewindefräser

- Für die Herstellung von Gewinden ab M 1,6
- Kurze Bearbeitungszeit durch höhere Nutenzahl
- Mit korrigiertem Gewindeprofil
- Abmessungsübergreifend
- Steigungsübergreifend

Circular thread milling cutters

- For the machining of threads from M 1.6
- Short machining time due to increased number of flutes
- With corrected thread profile
- For different thread sizes
- For different pitches

ZGF-S-CUT



Zirkular-Gewindefräser

- Für die Herstellung von Gewinden ab M 3
- Linksdrehendes Werkzeug
- Für Spezialwerkstoffe wie Inconel und Titan
- Mit korrigiertem Gewindeprofil
- Abmessungsübergreifend
- Steigungsgebunden

Circular thread milling cutters

- For the machining of threads from M 3
- Left-hand rotating tool
- For special materials like Inconel and Titanium
- With corrected thread profile
- For different thread sizes
- For one pitch only

ZGF-HCUT



Zirkular-Gewindefräser

- Für die Herstellung von Gewinden ab M 3
- Linksdrehendes Werkzeug
- Für Werkstoffe ab 44 HRC
- Mit korrigiertem Gewindeprofil
- Abmessungsübergreifend
- Steigungsgebunden

Circular thread milling cutters

- For the machining of threads from M 3
- Left-hand rotating tool
- For materials from 44 HRC
- With corrected thread profile
- For different thread sizes
- For one pitch only

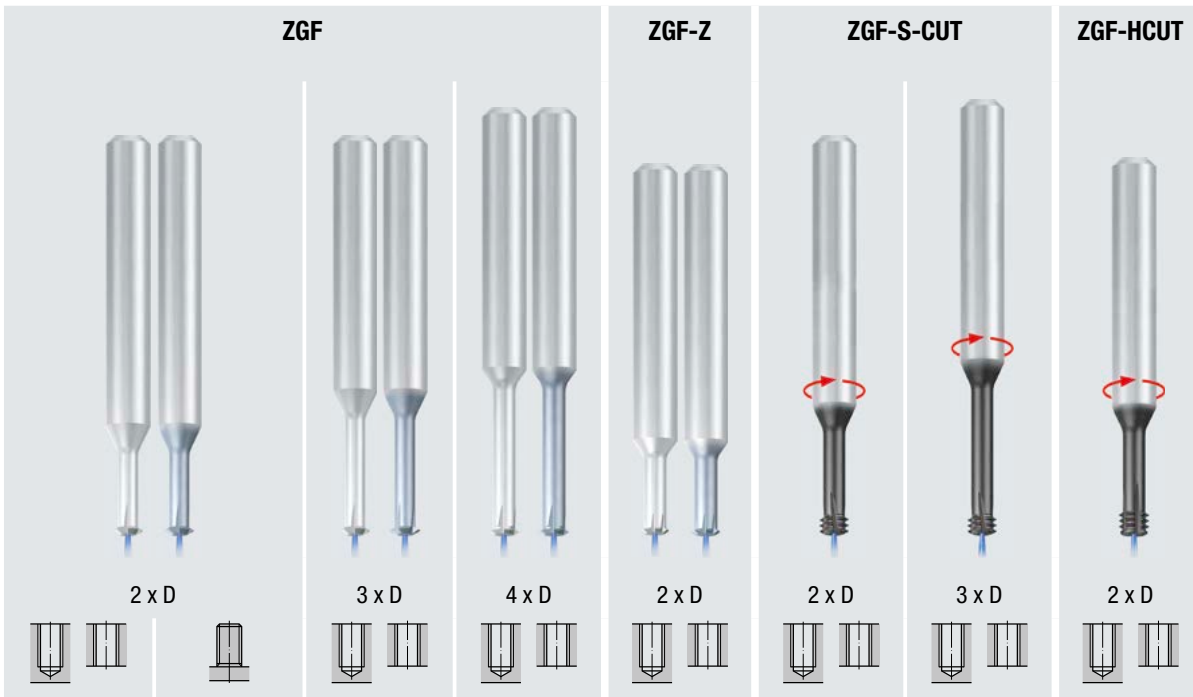

Seite · Page

8		9	10	11	12	12	13	M
8		9	10	11	12	12	13	MF
								UN
14		15			16	16		UNC
14		15			17	17		UNF
18	18							G (BSP)

Programmierbeispiele (DIN) siehe Seite 20 - 23
 Programming examples (DIN), see pages 20 - 23

Gewindefräszyklus · Thread milling cycle

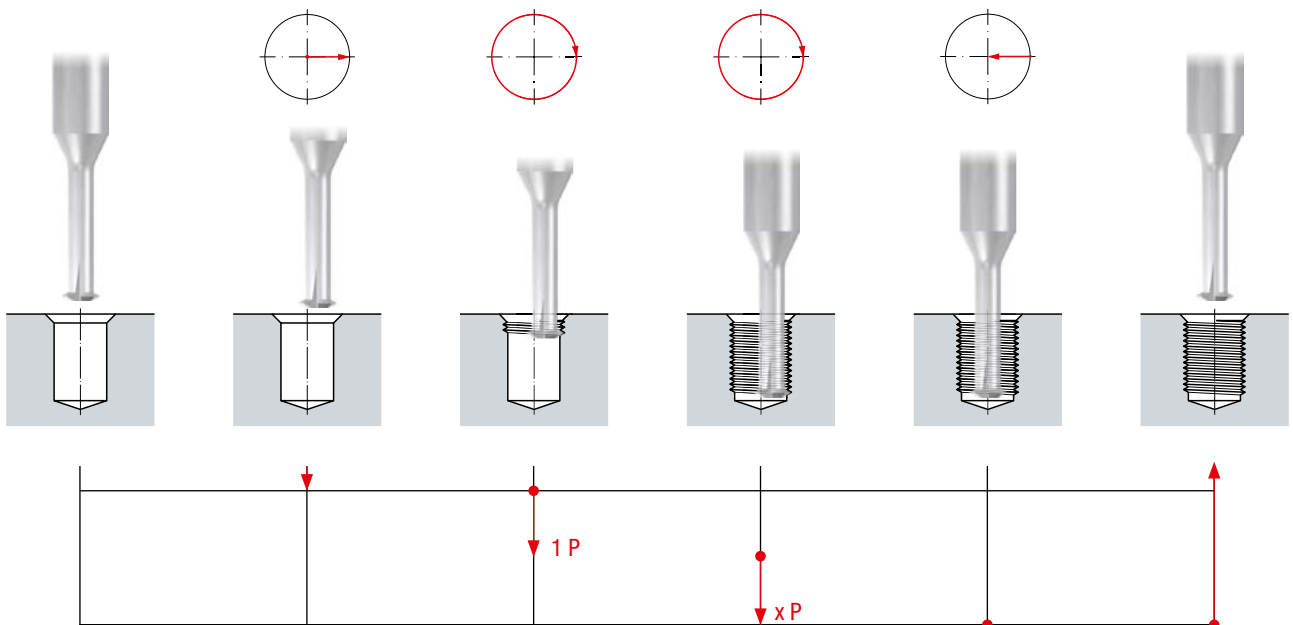

Wegweiser und Schnittwerte

Bitte beachten:

Die in den jeweiligen Spalten angegebenen Schnittwerte sind Richtwerte, welche je nach Einsatzbedingungen (Werkzeugspannung, Werkstückspannung, usw.) angepasst werden müssen.

Die Eignung ist folgendermaßen gekennzeichnet:

- Gewindefräser sehr gut geeignet
- Gewindefräser gut geeignet

v_c = Schnittgeschwindigkeit [m/min]

f_z = Vorschub pro Zahn [mm]

Product finder and cutting data

Please note:

The cutting values listed in the respective columns are standard values which have to be adjusted to individual work conditions (tool clamping, workpiece clamping, etc.).

The suitability is marked as follows:

- Thread milling cutter is very suitable
- Thread milling cutter is suitable

v_c = Cutting speed [m/min]

f_z = Feed per tooth [mm]

Einsatzgebiete – Material Range of application – material			Material-Beispiele Material examples	Material-Nummern Material numbers
P	Stahlwerkstoffe Steel materials			
	1.1 Kaltfließpressstähle, Baustähle, Automatenstähle, u.a.	Cold-extrusion steels, Construction steels, Free-cutting steels, etc.	≤ 600 N/mm ²	Cq15 1.1132 S235JR (St37-2) 1.0037 10SPb20 1.0722 E360 (St70-2) 1.0070 16MnCr5 1.7131 GS-25CrMo4 1.7218
	2.1 Baustähle, Einsatzstähle, Stahlguss, u.a.	Construction steels, Cementation steels, Steel castings, etc.	≤ 800 N/mm ²	20MoCr3 1.7320 42CrMo4 1.7225 102Cr6 1.2067 50CrMo4 1.7228
	3.1 Einsatzstähle, Vergütungsstähle, Kaltarbeitsstähle, u.a.	Cementation steels, Heat-treatable steels, Cold work steels, etc.	≤ 1000 N/mm ²	X45NiCrMo4 1.2767 31CrMo12 1.8515
	4.1 Vergütungsstähle, Kaltarbeitsstähle, Nitrierstähle, u.a.	Heat-treatable steels, Cold work steels, Nitriding steels, etc.	≤ 1200 N/mm ²	X38CrMoV5-3 1.2367 X100CrMoV8-1-1 1.2990 X40CrMoV5-1 1.2344
M	Nichtrostende Stahlwerkstoffe Stainless steel materials			
	1.1 Ferritisch, martensitisch	Ferritic, martensitic	≤ 950 N/mm ²	X2CrTi12 1.4512
	2.1 Austenitisch	Austenitic	≤ 950 N/mm ²	X6CrNiMoTi17-12-2 1.4571
	3.1 Austenitisch-ferritisch (Duplex)	Austenitic-ferritic (Duplex)	≤ 1100 N/mm ²	X2CrNiMoN22-5-3 1.4462
4.1 Austenitisch-ferritisch hitzebeständig (Super Duplex)	Austenitic-ferritic heat-resistant (Super Duplex)	≤ 1250 N/mm ²	X2CrNiMoN25-7-4 1.4410	
K	Gusswerkstoffe Cast materials			
	1.1 Gusseisen mit Lamellengrafit (GJL)	Cast iron with lamellar graphite (GJL)	100-250 N/mm ²	EN-GJL-200 (GG20) EN-JL-1030
	2.1 Gusseisen mit Kugelgrafit (GJS)	Cast iron with nodular graphite (GJS)	250-450 N/mm ²	EN-GJL-300 (GG30) EN-JL-1050
	2.2 Gusseisen mit Kugelgrafit (GJS)	Cast iron with nodular graphite (GJS)	350-500 N/mm ²	EN-GJS-400-15 (GGG40) EN-JS-1030
	3.1 Gusseisen mit Vermiculargrafit (GJV)	Cast iron with vermicular graphite (GJV)	500-900 N/mm ²	EN-GJS-700-2 (GGG70) EN-JS-1070
	3.2 Gusseisen mit Vermiculargrafit (GJV)	Cast iron with vermicular graphite (GJV)	300-400 N/mm ²	GJV 300
	4.1 Temperguss (GTMW, GTMB)	Malleable cast iron (GTMW, GTMB)	400-500 N/mm ²	GJV 450
4.2 Temperguss (GTMW, GTMB)	Malleable cast iron (GTMW, GTMB)	250-500 N/mm ²	EN-GJMW-350-4 (GTW-35) EN-JM-1010	
4.2 Temperguss (GTMW, GTMB)	Malleable cast iron (GTMW, GTMB)	500-800 N/mm ²	EN-GJMB-450-6 (GTS-45) EN-JM-1140	
N	Nichteisenwerkstoffe Non ferrous materials			
	Aluminium-Legierungen Aluminium alloys			
	1.1 Aluminium-Knetlegierungen	Aluminium wrought alloys	≤ 200 N/mm ²	EN AW-AlMn1 EN AW-3103
	1.2 Aluminium-Knetlegierungen	Aluminium wrought alloys	≤ 350 N/mm ²	EN AW-AlMgSi EN AW-6060
	1.3 Aluminium-Knetlegierungen	Aluminium wrought alloys	≤ 550 N/mm ²	EN AW-AlZn5Mg3Cu EN AW-7022
	1.4 Aluminium-Knetlegierungen	Aluminium wrought alloys	Si ≤ 7%	EN AC-AlMg5 EN AC-51300
	1.5 Aluminium-Gusslegierungen	Aluminium cast alloys	7% < Si ≤ 12%	EN AC-ALSi9Cu3 EN AC-46500
	1.6 Aluminium-Gusslegierungen	Aluminium cast alloys	12% < Si ≤ 17%	GD-AISi17Cu4FeMg
	Kupfer-Legierungen Copper alloys			
	2.1 Reinkupfer, niedriglegiertes Kupfer	Pure copper, low-alloyed copper	≤ 400 N/mm ²	E-Cu 57 EN CW 004 A
	2.2 Kupfer-Zink-Legierungen (Messing, langspanend)	Copper-zinc alloys (brass, long-chipping)	≤ 550 N/mm ²	CuZn37 (Ms63) EN CW 508 L
	2.3 Kupfer-Zink-Legierungen (Messing, kurzspanend)	Copper-zinc alloys (brass, short-chipping)	≤ 550 N/mm ²	CuZn36Pb3 (Ms58) EN CW 603 N
	2.4 Kupfer-Aluminium-Legierungen (Alubronze, langspanend)	Copper-aluminium alloys (alu bronze, long-chipping)	≤ 800 N/mm ²	CuAl10Ni5Fe4 EN CW 307 G
	2.5 Kupfer-Zinn-Legierungen (Zinnbronze, langspanend)	Copper-tin alloys (tin bronze, long-chipping)	≤ 700 N/mm ²	CuSn8P EN CW 459 K
	2.6 Kupfer-Zinn-Legierungen (Zinnbronze, kurzspanend)	Copper-tin alloys (tin bronze, short-chipping)	≤ 400 N/mm ²	CuSn7ZnPb (Rg7) 2.1090
	2.7 Kupfer-Sonderlegierungen	Special copper alloys	≤ 600 N/mm ²	(AMPPO® 8)
2.8 Kupfer-Sonderlegierungen	Special copper alloys	≤ 1400 N/mm ²	(AMPPO® 45)	
Magnesium-Legierungen Magnesium alloys				
3.1 Magnesium-Knetlegierungen	Magnesium wrought alloys	≤ 500 N/mm ²	MgAl6Zn 3.5612	
3.2 Magnesium-Gusslegierungen	Magnesium cast alloys	≤ 500 N/mm ²	EN-MCMgAl9Zn1 EN-MC21120	
Kunststoffe Synthetics				
4.1 Duroplaste (kurzspanend)	Duroplastics (short-chipping)		Bakelit, Pertinax	
4.2 Thermoplaste (langspanend)	Thermoplastics (long-chipping)		PMMA, POM, PVC	
4.3 Faserverstärkte Kunststoffe (Faseranteil ≤ 30%)	Fibre-reinforced synthetics (fibre content ≤ 30%)		GFK, CFK, AFK	
4.4 Faserverstärkte Kunststoffe (Faseranteil > 30%)	Fibre-reinforced synthetics (fibre content > 30%)		GFK, CFK, AFK	
Besondere Werkstoffe Special materials				
5.1 Grafit	Graphite		C 8000	
5.2 Wolfram-Kupfer-Legierungen	Tungsten-copper alloys		W-Cu 80/20	
5.3 Verbundwerkstoffe	Composite materials		Hyllite, Alucobond	
Spezialwerkstoffe Special materials				
Titan-Legierungen Titanium alloys				
1.1 Reintitan	Pure titanium	≤ 450 N/mm ²	Ti1 3.7025	
1.2 Titan-Legierungen	Titanium alloys	≤ 900 N/mm ²	TiAl6V4 3.7165	
1.3 Titan-Legierungen	Titanium alloys	≤ 1250 N/mm ²	TiAl4Mo4Sn2 3.7185	
Nickel-, Kobalt- und Eisen-Legierungen Nickel alloys, cobalt alloys and iron alloys				
2.1 Reinnickel	Pure nickel	≤ 600 N/mm ²	Ni 99.6 2.4060	
2.2 Nickel-Basis-Legierungen	Nickel-base alloys	≤ 1000 N/mm ²	Monel 400 2.4360	
2.3 Nickel-Basis-Legierungen	Nickel-base alloys	≤ 1600 N/mm ²	Inconel 718 2.4668	
2.4 Nickel-Basis-Legierungen	Nickel-base alloys	≤ 1000 N/mm ²	Udimet 605	
2.5 Kobalt-Basis-Legierungen	Cobalt-base alloys	≤ 1600 N/mm ²	Haynes 25 2.4964	
2.6 Eisen-Basis-Legierungen	Iron-base alloys	≤ 1500 N/mm ²	Incoloy 800 1.4958	
Harte Werkstoffe Hard materials				
1.1 Hochfeste Stähle, gehärtete Stähle, Hartguss	High strength steels, hardened steels, hard castings	44 - 50 HRC	Weldox 1100	
1.2 Hochfeste Stähle, gehärtete Stähle, Hartguss	High strength steels, hardened steels, hard castings	50 - 55 HRC	Hardox 550	
1.3 Hochfeste Stähle, gehärtete Stähle, Hartguss	High strength steels, hardened steels, hard castings	55 - 60 HRC	Armax 600T	
1.4 Hochfeste Stähle, gehärtete Stähle, Hartguss	High strength steels, hardened steels, hard castings	60 - 63 HRC	Ferro-Titanit	
1.5 Hochfeste Stähle, gehärtete Stähle, Hartguss	High strength steels, hardened steels, hard castings	63 - 66 HRC	HSSE	



ZGF



ZGF-Z



ZGF-S-CUT



ZGF-HCUT

V _c		f _z			V _c		f _z			V _c		f _z		
Unbesch. Uncoated	TICN	ø d ₁ ≤ 4 mm	ø d ₁ ≤ 8 mm	ø d ₁ > 8 mm	TIALN-T46	ø d ₁ ≤ 4 mm	ø d ₁ ≤ 8 mm	ø d ₁ > 8 mm	TIALN-T46	ø d ₁ ≤ 4 mm	ø d ₁ ≤ 8 mm	ø d ₁ > 8 mm		
40 - 100	80 - 250	0,005 - 0,04	0,04 - 0,07	0,05 - 0,15	80 - 250	0,01 - 0,04	0,04 - 0,07	0,05 - 0,15						1.1
30 - 80	60 - 200	0,005 - 0,04	0,04 - 0,07	0,05 - 0,15	60 - 200	0,01 - 0,04	0,04 - 0,07	0,05 - 0,15						2.1
20 - 60	40 - 150	0,005 - 0,03	0,03 - 0,05	0,04 - 0,12	40 - 150	0,01 - 0,03	0,03 - 0,05	0,04 - 0,12						3.1
20 - 60	40 - 120	0,003 - 0,02	0,02 - 0,05	0,04 - 0,12	40 - 120	0,006 - 0,02	0,02 - 0,05	0,04 - 0,12						4.1
20 - 60	40 - 100	0,003 - 0,02	0,02 - 0,05	0,04 - 0,12	40 - 100	0,006 - 0,02	0,02 - 0,05	0,04 - 0,12						5.1
40 - 120		0,003 - 0,03	0,03 - 0,05	0,04 - 0,12	40 - 120	0,006 - 0,03	0,03 - 0,05	0,04 - 0,12						1.1
40 - 120		0,003 - 0,03	0,03 - 0,05	0,04 - 0,12	40 - 120	0,006 - 0,03	0,03 - 0,05	0,04 - 0,12						2.1
30 - 80		0,003 - 0,02	0,02 - 0,05	0,04 - 0,10	30 - 80	0,006 - 0,02	0,02 - 0,05	0,04 - 0,10						3.1
30 - 60		0,003 - 0,02	0,02 - 0,04	0,03 - 0,08	30 - 60	0,006 - 0,02	0,02 - 0,04	0,03 - 0,08						4.1
80 - 140	100 - 250	0,008 - 0,04	0,04 - 0,07	0,05 - 0,15	100 - 250	0,015 - 0,04	0,04 - 0,07	0,05 - 0,15						1.1
80 - 140	100 - 250	0,008 - 0,04	0,04 - 0,07	0,05 - 0,15	100 - 250	0,015 - 0,04	0,04 - 0,07	0,05 - 0,15						1.2
60 - 120	80 - 200	0,008 - 0,04	0,04 - 0,07	0,05 - 0,15	80 - 200	0,015 - 0,04	0,04 - 0,07	0,05 - 0,15						2.1
60 - 120	80 - 200	0,008 - 0,04	0,04 - 0,07	0,05 - 0,15	80 - 200	0,015 - 0,04	0,04 - 0,07	0,05 - 0,15						2.2
60 - 120	80 - 200	0,008 - 0,04	0,04 - 0,07	0,05 - 0,15	80 - 200	0,015 - 0,04	0,04 - 0,07	0,05 - 0,15						3.1
60 - 120	80 - 200	0,008 - 0,04	0,04 - 0,07	0,05 - 0,15	80 - 200	0,015 - 0,04	0,04 - 0,07	0,05 - 0,15						3.2
60 - 120	80 - 200	0,008 - 0,04	0,04 - 0,07	0,05 - 0,15	80 - 200	0,015 - 0,04	0,04 - 0,07	0,05 - 0,15						4.1
60 - 120	80 - 200	0,008 - 0,04	0,04 - 0,07	0,05 - 0,15	80 - 200	0,015 - 0,04	0,04 - 0,07	0,05 - 0,15						4.2
100 - 250	150 - 400	0,01 - 0,05	0,05 - 0,08	0,07 - 0,20	150 - 400	0,02 - 0,05	0,05 - 0,08	0,07 - 0,20						1.1
100 - 250	150 - 400	0,01 - 0,05	0,05 - 0,08	0,07 - 0,20	150 - 400	0,02 - 0,05	0,05 - 0,08	0,07 - 0,20						1.2
100 - 250	150 - 400	0,01 - 0,05	0,05 - 0,08	0,07 - 0,20	150 - 400	0,02 - 0,05	0,05 - 0,08	0,07 - 0,20						1.3
150 - 250	150 - 400	0,01 - 0,05	0,05 - 0,08	0,07 - 0,20	150 - 400	0,02 - 0,05	0,05 - 0,08	0,07 - 0,20						1.4
150 - 250	150 - 400	0,01 - 0,05	0,05 - 0,08	0,07 - 0,20	150 - 400	0,02 - 0,05	0,05 - 0,08	0,07 - 0,20						1.5
	100 - 200	0,01 - 0,05	0,05 - 0,08	0,07 - 0,20	100 - 200	0,02 - 0,05	0,05 - 0,08	0,07 - 0,20						1.6
100 - 250	150 - 400	0,008 - 0,05	0,05 - 0,08	0,07 - 0,20	150 - 400	0,015 - 0,05	0,05 - 0,08	0,07 - 0,20						2.1
100 - 250	150 - 400	0,008 - 0,05	0,05 - 0,08	0,07 - 0,20	150 - 400	0,015 - 0,05	0,05 - 0,08	0,07 - 0,20						2.2
100 - 250	150 - 400	0,008 - 0,05	0,05 - 0,08	0,07 - 0,20	150 - 400	0,015 - 0,05	0,05 - 0,08	0,07 - 0,20						2.3
60 - 150	100 - 250	0,008 - 0,04	0,04 - 0,07	0,05 - 0,15	100 - 250	0,015 - 0,04	0,04 - 0,07	0,05 - 0,15						2.4
60 - 150	100 - 250	0,008 - 0,04	0,04 - 0,07	0,05 - 0,15	100 - 250	0,015 - 0,04	0,04 - 0,07	0,05 - 0,15						2.5
60 - 150	100 - 250	0,008 - 0,04	0,04 - 0,07	0,05 - 0,15	100 - 250	0,015 - 0,04	0,04 - 0,07	0,05 - 0,15						2.6
80 - 200	100 - 250	0,008 - 0,04	0,04 - 0,07	0,05 - 0,15	100 - 250	0,015 - 0,04	0,04 - 0,07	0,05 - 0,15						2.7
	40 - 80	0,003 - 0,02	0,02 - 0,05	0,04 - 0,15	40 - 80	0,006 - 0,02	0,02 - 0,05	0,04 - 0,15						2.8
	30 - 60	0,003 - 0,02	0,02 - 0,05	0,04 - 0,15	30 - 60	0,006 - 0,02	0,02 - 0,05	0,04 - 0,15						2.8
150 - 250	150 - 400	0,01 - 0,05	0,05 - 0,08	0,07 - 0,20	150 - 400	0,02 - 0,05	0,05 - 0,08	0,07 - 0,20						3.1
150 - 250	150 - 400	0,01 - 0,05	0,05 - 0,08	0,07 - 0,20	150 - 400	0,02 - 0,05	0,05 - 0,08	0,07 - 0,20						3.2
60 - 150	100 - 400	0,01 - 0,05	0,05 - 0,10	0,08 - 0,25	100 - 400	0,02 - 0,05	0,05 - 0,10	0,08 - 0,25						4.1
60 - 150	100 - 400	0,01 - 0,05	0,05 - 0,10	0,08 - 0,25	100 - 400	0,02 - 0,05	0,05 - 0,10	0,08 - 0,25						4.2
	80 - 120	0,01 - 0,05	0,05 - 0,10	0,08 - 0,25	80 - 120	0,02 - 0,05	0,05 - 0,10	0,08 - 0,25						4.3
	80 - 120	0,01 - 0,05	0,05 - 0,10	0,08 - 0,25	80 - 120	0,02 - 0,05	0,05 - 0,10	0,08 - 0,25						4.4
	100 - 200		0,04 - 0,07	0,08 - 0,25	100 - 200	0,015 - 0,04	0,04 - 0,07	0,08 - 0,25						5.1
15 - 40	30 - 60		0,02 - 0,04	0,03 - 0,08	30 - 60	0,006 - 0,02	0,02 - 0,04	0,03 - 0,08						5.2
														5.3
15 - 50	30 - 100	0,003 - 0,03	0,03 - 0,05	0,04 - 0,10	30 - 100	0,006 - 0,03	0,03 - 0,05	0,04 - 0,10						1.1
15 - 50	30 - 80	0,003 - 0,03	0,03 - 0,05	0,04 - 0,10	30 - 80	0,006 - 0,03	0,03 - 0,05	0,04 - 0,10						1.2
15 - 40	30 - 60	0,003 - 0,02	0,02 - 0,04	0,03 - 0,08	30 - 60	0,006 - 0,02	0,02 - 0,04	0,03 - 0,08						1.3
30 - 60		0,003 - 0,02	0,02 - 0,04	0,03 - 0,08	30 - 60	0,006 - 0,02	0,02 - 0,04	0,03 - 0,08						2.1
30 - 60		0,003 - 0,02	0,02 - 0,04	0,03 - 0,08	30 - 60	0,006 - 0,02	0,02 - 0,04	0,03 - 0,08						2.2
30 - 40		0,003 - 0,02	0,02 - 0,04	0,03 - 0,08	30 - 40	0,006 - 0,02	0,02 - 0,04	0,03 - 0,08						2.3
30 - 60		0,003 - 0,02	0,02 - 0,04	0,03 - 0,08	30 - 60	0,006 - 0,02	0,02 - 0,04	0,03 - 0,08						2.4
30 - 40		0,003 - 0,02	0,02 - 0,04	0,03 - 0,08	30 - 40	0,006 - 0,02	0,02 - 0,04	0,03 - 0,08						2.5
30 - 40		0,003 - 0,02	0,02 - 0,04	0,03 - 0,08	30 - 40	0,006 - 0,02	0,02 - 0,04	0,03 - 0,08						2.6
30 - 60			0,015 - 0,04	0,03 - 0,08	30 - 60		0,01 - 0,04	0,03 - 0,08	30 - 60	0,006 - 0,015	0,01 - 0,04	0,03 - 0,08		1.1
30 - 60			0,015 - 0,04	0,03 - 0,08	30 - 60		0,01 - 0,04	0,03 - 0,08	30 - 60	0,006 - 0,015	0,01 - 0,04	0,03 - 0,08		1.2
									30 - 60	0,003 - 0,010	0,005 - 0,03	0,02 - 0,06		1.3
									30 - 60	0,003 - 0,010	0,005 - 0,03	0,02 - 0,06		1.4
									30 - 60	0,003 - 0,010	0,005 - 0,03	0,02 - 0,06		1.5

M, MF

DIN 13

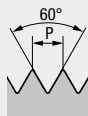

Für Innengewinde
For internal threads

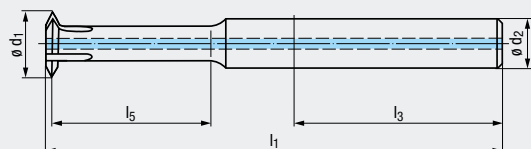

VHM

RH + LH

Z1 - Z5

DIN 6535

HA

HB

ø D



Gewindetiefe
Thread depth

2 x D

Einsatzgebiete – Material
Applications – material



P 1.1-5.1 K 1.1-4.2 N 1.1-5, 2.1-6
N 3.1-2 N 4.1-2, 5.2 S 1.1-3

ø D	P _{max.} mm	l ₁	l ₃	l ₅	ø d ₁	ø d ₂	Z	ZGF 2xD IKZ-HA		ZGF 2xD IKZ-HB	
M1 - M1,2 ¹⁾	0,25	39	28	2,8	0,7	3	1	GF243701.0010	●		
M1,4 - M1,8 ¹⁾	0,35	39	28	3,5	1,04	3	2	GF253701.0014	●		
M2 - M2,3 ¹⁾	0,45	39	28	4,8	1,52	3	3	GF253701.0020	●		
M2,5 - M3 ¹⁾	0,5	39	28	6	1,95	3	3	GF253701.0025	●		
M3,5 - M4,5 ¹⁾	0,75	42	28	9	2,78	4	3	GF253701.0035	●		
M5 - M7 ¹⁾	1	55	36	14	4	6	4	GF253701.0050	●	GF253101.0050	●
M8 - M10	1,5	62	36	19,8	6,5	8	5	GF253701.0080	●	GF253101.0080	●
M12 - M16	2	78	40	31,8	9,9	10	5	GF253701.0112	●	GF253101.0112	●

TICN



Einsatzgebiete – Material
Applications – material



P 1.1-5.1 M 1.1-4.1 K 1.1-4.2
N 1.1-5.2 S 1.1-2.6 H 1.1-2

ø D	P _{max.} mm	l ₁	l ₃	l ₅	ø d ₁	ø d ₂	Z	ZGF 2xD IKZ-HA TICN		ZGF 2xD IKZ-HB TICN	
M1 - M1,2 ¹⁾	0,25	39	28	2,8	0,7	3	1	GF243706.0010	●		
M1,4 - M1,8 ¹⁾	0,35	39	28	3,5	1,04	3	2	GF253706.0014	●		
M2 - M2,3 ¹⁾	0,45	39	28	4,8	1,52	3	3	GF253706.0020	●		
M2,5 - M3 ¹⁾	0,5	39	28	6	1,95	3	3	GF253706.0025	●		
M3,5 - M4,5 ¹⁾	0,75	42	28	9	2,78	4	3	GF253706.0035	●		
M5 - M7 ¹⁾	1	55	36	14	4	6	4	GF253706.0050	●	GF253106.0050	●
M8 - M10	1,5	62	36	19,8	6,5	8	5	GF253706.0080	●	GF253106.0080	●
M12 - M16	2	78	40	31,8	9,9	10	5	GF253706.0112	●	GF253106.0112	●

¹⁾ Ausführung ohne innere Kühlschmierstoff-Zufuhr IKZ
Design without internal coolant supply IKZ

Andere Ausführungen auf Anfrage
Other designs upon request

Auch für Metrisches Feingewinde (MF) und teilweise auch für UN-Gewinde verwendbar
Suitable also for Metric fine threads (MF) and partly also for UN threads

M, MF

DIN 13

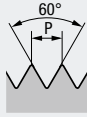

VHM

RH + LH

Z1 - Z5



DIN 6535



Für Innengewinde
For internal threads

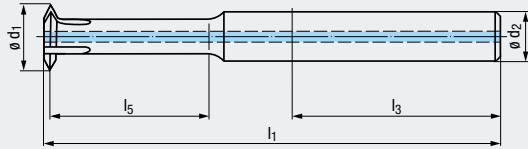

Gewindetiefe
Thread depth

3 x D

Einsatzgebiete – Material
Applications – material

P 1.1-5.1 K 1.1-4.2 N 1.1-5, 2.1-6
N 3.1-2 N 4.1-2, 5.2 S 1.1-3

ø D	P _{max.} mm	l ₁	l ₃	l ₅	ø d ₁	ø d ₂	Z	ZGF 3xD IKZ-HA		ZGF 3xD IKZ-HB	
M1	0,25	39	28	3,1	0,7	3	1	GF273701.0010	●		
M1,6	0,35	39	28	4,95	1,18	3	2	GF273701.0016	●		
M2	0,4	39	28	6,2	1,52	3	3	GF273701.0020	●		
M2,5	0,45	39	28	7,7	1,96	3	3	GF273701.0025	●		
M3	0,5	41	28	9,25	2,4	3	3	GF273701.0030	●		
M4	0,7	44	28	12,35	3,15	4	3	GF273701.0040	●		
M5	0,8	56	36	15,4	4,04	6	4	GF273701.0050	●	GF273101.0050	●
M6	1	59	36	18,5	4,8	6	4	GF273701.0060	●	GF273101.0060	●
M8	1,25	65	36	24,65	6,5	8	5	GF273701.0080	●	GF273101.0080	●
M10	1,5	77	40	30,75	8,2	10	5	GF273701.0100	●	GF273101.0100	●
M12	1,75	82	40	36,85	9,9	10	5	GF273701.0112	●	GF273101.0112	●
M14	2	94	45	43	11,6	12	5	GF273701.0114	●	GF273101.0114	●
M16	2	100	45	49	13,6	14	5	GF273701.0116	●	GF273101.0116	●

TICN



Einsatzgebiete – Material
Applications – material

P 1.1-5.1 M 1.1-4.1 K 1.1-4.2
N 1.1-5.2 S 1.1-2.6 H 1.1-2

ø D	P _{max.} mm	l ₁	l ₃	l ₅	ø d ₁	ø d ₂	Z	ZGF 3xD IKZ-HA TICN		ZGF 3xD IKZ-HB TICN	
M1	0,25	39	28	3,1	0,7	3	1	GF273706.0010	●		
M1,6	0,35	39	28	4,95	1,18	3	2	GF273706.0016	●		
M2	0,4	39	28	6,2	1,52	3	3	GF273706.0020	●		
M2,5	0,45	39	28	7,7	1,96	3	3	GF273706.0025	●		
M3	0,5	41	28	9,25	2,4	3	3	GF273706.0030	●		
M4	0,7	44	28	12,35	3,15	4	3	GF273706.0040	●		
M5	0,8	56	36	15,4	4,04	6	4	GF273706.0050	●	GF273106.0050	●
M6	1	59	36	18,5	4,8	6	4	GF273706.0060	●	GF273106.0060	●
M8	1,25	65	36	24,65	6,5	8	5	GF273706.0080	●	GF273106.0080	●
M10	1,5	77	40	30,75	8,2	10	5	GF273706.0100	●	GF273106.0100	●
M12	1,75	82	40	36,85	9,9	10	5	GF273706.0112	●	GF273106.0112	●
M14	2	94	45	43	11,6	12	5	GF273706.0114	●	GF273106.0114	●
M16	2	100	45	49	13,6	14	5	GF273706.0116	●	GF273106.0116	●

1) Ausführung ohne innere Kühlschmierstoff-Zufuhr IKZ
Design without internal coolant supply IKZ

Andere Ausführungen auf Anfrage
Other designs upon request

Auch für Metrisches Feingewinde (MF) und teilweise auch für UN-Gewinde verwendbar
Suitable also for Metric fine threads (MF) and partly also for UN threads

M, MF

DIN 13

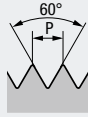

Für Innengewinde
For internal threads

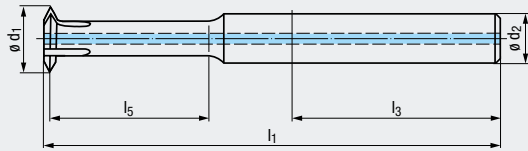

VHM

RH + LH

Z2 - Z5

DIN 6535



ø D



Gewindetiefe
Thread depth

4 x D

Einsatzgebiete – Material
Applications – material

P 1.1-5.1 K 1.1-4.2 N 1.1-5, 2.1-6
N 3.1-2 N 4.1-2, 5.2 S 1.1-3

ø D	P _{max.} mm	l ₁	l ₃	l ₅	ø d ₁	ø d ₂	Z	ZGF 4xD IKZ-HA	ZGF 4xD HB IKZ-
M1,6 ¹⁾	0,35	39	28	6,58	1,18	3	2	GF2A3701.0016	●
M2 ¹⁾	0,4	39	28	8,2	1,52	3	3	GF2A3701.0020	●
M2,5 ¹⁾	0,45	40	28	10,23	1,96	3	3	GF2A3701.0025	●
M3 ¹⁾	0,5	42	28	12,25	2,4	3	3	GF2A3701.0030	●
M4 ¹⁾	0,7	46	28	16,35	3,15	4	3	GF2A3701.0040	●
M5 ¹⁾	0,8	59	36	20,4	4,04	6	4	GF2A3701.0050	● GF2A3101.0050 ●
M6 ¹⁾	1	63	36	24,5	4,8	6	4	GF2A3701.0060	● GF2A3101.0060 ●
M8	1,25	72	36	32,63	6,5	8	5	GF2A3701.0080	● GF2A3101.0080 ●
M10	1,5	84	40	40,75	8,2	10	5	GF2A3701.0100	● GF2A3101.0100 ●
M12	1,75	92	40	48,88	9,9	10	5	GF2A3701.0112	● GF2A3101.0112 ●

TICN



Einsatzgebiete – Material
Applications – material

P 1.1-5.1 M 1.1-4.1 K 1.1-4.2
N 1.1-5.2 S 1.1-2.6 H 1.1-2

ø D	P _{max.} mm	l ₁	l ₃	l ₅	ø d ₁	ø d ₂	Z	ZGF 4xD IKZ-HA TICN	ZGF 4xD IKZ-HB TICN
M1,6 ¹⁾	0,35	39	28	6,58	1,18	3	2	GF2A3706.0016	●
M2 ¹⁾	0,4	39	28	8,2	1,52	3	3	GF2A3706.0020	●
M2,5 ¹⁾	0,45	40	28	10,23	1,96	3	3	GF2A3706.0025	●
M3 ¹⁾	0,5	42	28	12,25	2,4	3	3	GF2A3706.0030	●
M4 ¹⁾	0,7	46	28	16,35	3,15	4	3	GF2A3706.0040	●
M5 ¹⁾	0,8	59	36	20,4	4,04	6	4	GF2A3706.0050	● GF2A3106.0050 ●
M6 ¹⁾	1	63	36	24,5	4,8	6	4	GF2A3706.0060	● GF2A3106.0060 ●
M8	1,25	72	36	32,63	6,5	8	5	GF2A3706.0080	● GF2A3106.0080 ●
M10	1,5	84	40	40,75	8,2	10	5	GF2A3706.0100	● GF2A3106.0100 ●
M12	1,75	92	40	48,88	9,9	10	5	GF2A3706.0112	● GF2A3106.0112 ●

¹⁾ Ausführung ohne innere Kühlschmierstoff-Zufuhr IKZ
Design without internal coolant supply IKZ

Andere Ausführungen auf Anfrage
Other designs upon request

Auch für Metrisches Feingewinde (MF) und teilweise auch für UN-Gewinde verwendbar
Suitable also for Metric fine threads (MF) and partly also for UN threads

M, MF

DIN 13

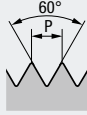

Für Innengewinde
For internal threads

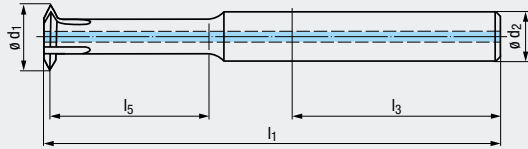

VHM

RH + LH

Z5 - Z8



DIN 6535



2 x D

Gewindetiefe
Thread depth

Einsatzgebiete – Material
Applications – material

P 1.1-5.1 K 1.1-4.2 N 1.1-5, 2.1-6
N 3.1-2 N 4.1-2, 5.2 S 1.1-3

ø D	P _{max.} mm	l ₁	l ₃	l ₅	ø d ₁	ø d ₂	Z	ZGF-Z 2xD IKZ-HA		ZGF-Z 2xD IKZ-HB	
								Part No.	Availability	Part No.	Availability
M1,6	0,35	39	28	3,38	1,18	3	5	GF293741.0016	●		
M2	0,4	39	28	4,2	1,52	3	6	GF293741.0020	●		
M2,5	0,45	39	28	5,23	1,96	3	6	GF293741.0025	●		
M3	0,5	39	28	6,25	2,4	3	6	GF293741.0030	●		
M4	0,7	41	28	8,35	3,15	4	6	GF293741.0040	●		
M5	0,8	51	36	10,4	4,04	6	7	GF293741.0050	●	GF293141.0050	●
M6	1	53	36	12,5	4,8	6	7	GF293741.0060	●	GF293141.0060	●
M8	1,25	58	36	16,63	6,5	8	7	GF293741.0080	●	GF293141.0080	●
M10	1,5	67	40	20,75	8,2	10	8	GF293741.0100	●	GF293141.0100	●
M12	1,75	70	40	24,88	9,9	10	8	GF293741.0112	●	GF293141.0112	●

TICN



Einsatzgebiete – Material
Applications – material

P 1.1-5.1 M 1.1-4.1 K 1.1-4.2
N 1.1-5.2 S 1.1-2.6 H 1.1-2

ø D	P _{max.} mm	l ₁	l ₃	l ₅	ø d ₁	ø d ₂	Z	ZGF-Z 2xD IKZ-HA TICN		ZGF-Z 2xD IKZ-HB TICN	
								Part No.	Availability	Part No.	Availability
M1,6	0,35	39	28	3,38	1,18	3	5	GF293746.0016	●		
M2	0,4	39	28	4,2	1,52	3	6	GF293746.0020	●		
M2,5	0,45	39	28	5,23	1,96	3	6	GF293746.0025	●		
M3	0,5	39	28	6,25	2,4	3	6	GF293746.0030	●		
M4	0,7	41	28	8,35	3,15	4	6	GF293746.0040	●		
M5	0,8	51	36	10,4	4,04	6	7	GF293746.0050	●	GF293146.0050	●
M6	1	53	36	12,5	4,8	6	7	GF293746.0060	●	GF293146.0060	●
M8	1,25	58	36	16,63	6,5	8	7	GF293746.0080	●	GF293146.0080	●
M10	1,5	67	40	20,75	8,2	10	8	GF293746.0100	●	GF293146.0100	●
M12	1,75	70	40	24,88	9,9	10	8	GF293746.0112	●	GF293146.0112	●

1) Ausführung ohne innere Kühlschmierstoff-Zufuhr IKZ
Design without internal coolant supply IKZ

Andere Ausführungen auf Anfrage
Other designs upon request

Auch für Metrisches Feingewinde (MF) und teilweise auch für UN-Gewinde verwendbar
Suitable also for Metric fine threads (MF) and partly also for UN threads

M, MF

DIN 13

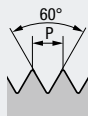

Für Innengewinde
For internal threads

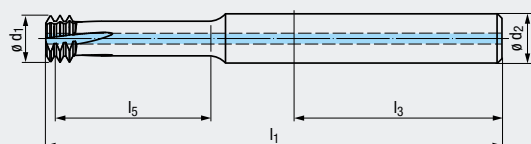

VHM	TIALN T46
RH + LH	LH-rot.
L10	Z4 - Z6
DIN 6535	ø D
HA	
HB	



Gewindetiefe
Thread depth

2 x D

Einsatzgebiete – Material
Applications – material

P 1.1-5.1	M 1.1-4.1	K 1.1-4.2
N 1.1-5.2	S 1.1-2.6	H 1.1-2

ø D	P mm	l ₁	l ₃	l ₅	ø d ₁	ø d ₂	Z	ZGF-S-CUT 2xD		ZGF-S-CUT 2xD	
								IKZ-HA TIALN-T46	IKZ-HB TIALN-T46	IKZ-HA TIALN-T46	IKZ-HB TIALN-T46
M 3 ¹⁾	0,5	39	28	6,2	2,4	3	4	GF26A729.0030	●		
M 3,5 ¹⁾	0,6	39	28	7,3	2,78	3	4	GF26A729.0035	●		
M 4 ¹⁾	0,7	42	28	8,3	3,15	4	4	GF26A729.0040	●		
M 5	0,8	52	36	10,3	4,04	6	4	GF26A729.0050	●	GF26A129.0050	●
M 6	1	55	36	12,43	4,8	6	4	GF26A729.0060	●	GF26A129.0060	●
M 8	1,25	60	36	16,7	6,5	8	4	GF26A729.0080	●	GF26A129.0080	●
M10	1,5	70	40	20,7	8,2	10	5	GF26A729.0100	●	GF26A129.0100	●
M12	1,75	74	40	24,9	9,9	10	5	GF26A729.0112	●	GF26A129.0112	●
M14	2	80	45	29	11,6	12	5	GF26A729.0114	●	GF26A129.0114	●
M16	2	85	45	33	13,6	14	6	GF26A729.0116	●	GF26A129.0116	●

Gewindetiefe
Thread depth

3 x D

Einsatzgebiete – Material
Applications – material

P 1.1-5.1	M 1.1-4.1	K 1.1-4.2
N 1.1-5.2	S 1.1-2.6	H 1.1-2

ø D	P mm	l ₁	l ₃	l ₅	ø d ₁	ø d ₂	Z	ZGF-S-CUT 3xD		ZGF-S-CUT 3xD	
								IKZ-HA TIALN-T46	IKZ-HB TIALN-T46	IKZ-HA TIALN-T46	IKZ-HB TIALN-T46
M 3 ¹⁾	0,5	41	28	9,3	2,4	3	4	GF2BA729.0030	●		
M 4 ¹⁾	0,7	44	28	12,4	3,15	4	4	GF2BA729.0040	●		
M 5	0,8	57	36	15,4	4,04	6	4	GF2BA729.0050	●	GF2BA129.0050	●
M 6	1	60	36	18,5	4,8	6	4	GF2BA729.0060	●	GF2BA129.0060	●
M 8	1,25	67	36	24,6	6,5	8	4	GF2BA729.0080	●	GF2BA129.0080	●
M10	1,5	78	40	30,8	8,2	10	5	GF2BA729.0100	●	GF2BA129.0100	●
M12	1,75	83	40	36,9	9,9	10	5	GF2BA729.0112	●	GF2BA129.0112	●
M14	2	95	45	43	11,6	12	5	GF2BA729.0114	●	GF2BA129.0114	●
M16	2	101	45	49	13,6	14	6	GF2BA729.0116	●	GF2BA129.0116	●

¹⁾ Ausführung ohne innere Kühlschmierstoff-Zufuhr IKZ
Design without internal coolant supply IKZ

Andere Ausführungen auf Anfrage
Other designs upon request

Auch für Metrisches Feingewinde (MF) verwendbar
Suitable also for Metric fine threads (MF)

M, MF

DIN 13

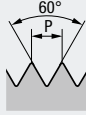

Für Innengewinde
For internal threads

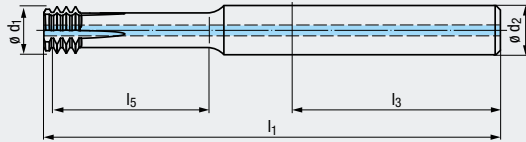

VHM TIALN T46

RH + LH LH-rot.

Z4 - Z6

DIN 6535

HA HB

ø D

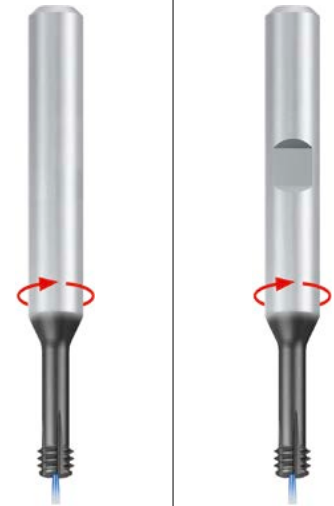

Gewindetiefe
Thread depth

2 x D

Einsatzgebiete – Material
Applications – material

H 1.1-5

ø D	P mm	l ₁	l ₃	l ₅	ø d ₁	ø d ₂	Z	ZGF-HCUT 2xD	
								IKZ-HA TIALN-T46	IKZ-HB TIALN-T46
M 3 ¹⁾	0,5	51	36	6,25	2,4	6	4	GF283729.0030	● GF283129.0030 ●
M 4 ¹⁾	0,7	51	36	8,35	3,15	6	4	GF283729.0040	● GF283129.0040 ●
M 5	0,8	52	36	10,4	4,04	6	4	GF283729.0050	● GF283129.0050 ●
M 6	1	55	36	12,3	4,8	6	4	GF283729.0060	● GF283129.0060 ●
M 8	1,25	60	36	16,6	6,5	8	4	GF283729.0080	● GF283129.0080 ●
M10	1,5	70	40	20,75	8,2	10	5	GF283729.0100	● GF283129.0100 ●
M12	1,75	74	40	24,85	9,9	10	5	GF283729.0112	● GF283129.0112 ●
M14	2	85	45	29	11,6	12	5	GF283729.0114	● GF283129.0114 ●
M16	2	90	45	33	13,6	14	5	GF283729.0116	● GF283129.0116 ●
M20	2,5	102	48	41,25	17	18	6	GF283729.0120	● GF283129.0120 ●

²⁾ Ausführung ohne innere Kühlschmierstoff-Zufuhr IKZ
Design without internal coolant supply IKZ

Andere Ausführungen auf Anfrage
Other designs upon request

Auch für Metrisches Feingewinde (MF) verwendbar
Suitable also for Metric fine threads (MF)

UNC, UNF

ASME B1.1

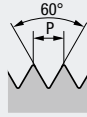

Für Innengewinde
For internal threads

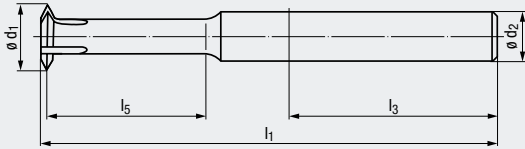

VHM

RH + LH



DIN 6535
HA

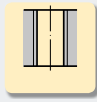
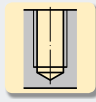
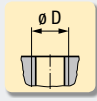

Gewindetiefe
Thread depth

2 x D

Einsatzgebiete – Material
Applications – material 6

P 1.1-5.1 K 1.1-4.2 N 1.1-5, 2.1-6
N 3.1-2 N 4.1-2, 5.2 S 1.1-3

ø D	P _{max.} mm	l ₁	l ₃	l ₅	ø d ₁	ø d ₂	Z
Nr. 4 - 40	0,635	39	28	6,35	2,06	3	3
Nr. 6 - 32	0,794	39	28	7	2,55	3	3
Nr. 8 - 32	0,794	42	28	8,35	3,21	4	3

ZGF	2xD	HA
GF253701.5003	●	
GF253701.5005	●	
GF253701.5006	●	

TICN



Einsatzgebiete – Material
Applications – material 6

P 1.1-5.1 M 1.1-4.1 K 1.1-4.2
N 1.1-5.2 S 1.1-2.6 H 1.1-2

ø D	P _{max.} mm	l ₁	l ₃	l ₅	ø d ₁	ø d ₂	Z
Nr. 4 - 40	0,635	39	28	6,35	2,06	3	3
Nr. 6 - 32	0,794	39	28	7	2,55	3	3
Nr. 8 - 32	0,794	42	28	8,35	3,21	4	3

ZGF	2xD	HA	TICN
GF253706.5003	●		
GF253706.5005	●		
GF253706.5006	●		

Auch für UNF-Gewinde verwendbar
Suitable also for UNF threads

Andere Ausführungen auf Anfrage
Other designs upon request

UNC

ASME B1.1

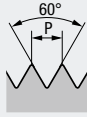

Für Innengewinde
For internal threads

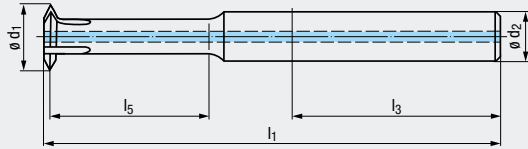

VHM **TICN**

RH + LH

Z3 - Z5 **DIN 6535**

HA HB

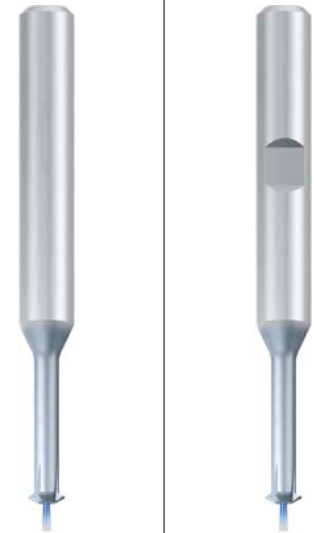

Gewindetiefe
Thread depth

3 x D

Einsatzgebiete – Material
Applications – material 6

P 1.1-5.1 **M** 1.1-4.1 **K** 1.1-4.2
N 1.1-5.2 **S** 1.1-2.6 **H** 1.1-2

ø D	P _{max.} mm	l ₁	l ₃	l ₅	ø d ₁	ø d ₂	Z	ZGF 3xD IKZ-HA TICN	ZGF 3xD IKZ-HB TICN
Nr. 2 - 56 ¹⁾	0,454	39	28	6,75	1,7	3	3	GF273706.5001	●
Nr. 4 - 40 ¹⁾	0,635	40	28	8,85	2,15	3	3	GF273706.5003	●
Nr. 6 - 32 ¹⁾	0,794	42	28	10,9	2,7	3	3	GF273706.5005	●
Nr. 10 - 24 ¹⁾	1,058	46	28	15	3,7	4	3	GF273706.5007	●
1/4 - 20 ¹⁾	1,27	59	36	20,15	4,95	6	4	GF273706.5009	● GF273106.5009 ●
5/16 - 18	1,411	65	36	24,5	6,3	8	4	GF273706.5010	● GF273106.5010 ●
3/8 - 16	1,588	68	36	29,38	7,7	8	5	GF273706.5011	● GF273106.5011 ●

UNF

ASME B1.1



Einsatzgebiete – Material
Applications – material 6

P 1.1-5.1 **M** 1.1-4.1 **K** 1.1-4.2
N 1.1-5.2 **S** 1.1-2.6 **H** 1.1-2

ø D	P _{max.} mm	l ₁	l ₃	l ₅	ø d ₁	ø d ₂	Z	ZGF 3xD IKZ-HA TICN	ZGF 3xD IKZ-HB TICN
Nr. 10 - 32 ¹⁾	0,794	46	28	14,85	3,9	4	4	GF273706.5041	●
1/4 - 28 ¹⁾	0,907	59	36	19,5	5,25	6	4	GF273706.5043	● GF273106.5043 ●
5/16 - 24 ¹⁾	1,058	65	36	24,3	6,6	8	5	GF273706.5044	● GF273106.5044 ●
7/16 - 20	1,27	77	40	33,95	9,55	10	5	GF273706.5046	● GF273106.5046 ●

¹⁾ Ausführung ohne innere Kühlschmierstoff-Zufuhr IKZ
Design without internal coolant supply IKZ

Andere Ausführungen auf Anfrage
Other designs upon request

Teilweise auch für Metrische Gewinde verwendbar
Partly suitable also for Metric threads

UNC

ASME B1.1

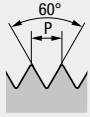

Für Innengewinde
For internal threads

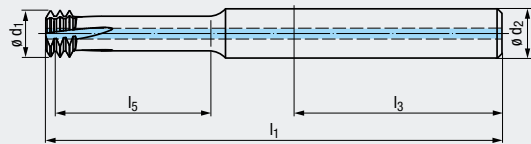

VHM	TIALN T46
RH + LH	LH-rot.
L10	Z3 - Z6
DIN 6535	ø D
HA	
HB	



Gewindetiefe
Thread depth

2 x D

Einsatzgebiete – Material
Applications – material

P 1.1-5.1	M 1.1-4.1	K 1.1-4.2
N 1.1-5.2	S 1.1-2.6	H 1.1-2

ø D	P mm	l ₁	l ₃	l ₅	ø d ₁	ø d ₂	Z	ZGF-S-CUT 2xD	
								IKZ-HA TIALN-T46	IKZ-HB TIALN-T46
Nr. 2 - 56 ¹⁾	0,454	39	28	4,6	1,7	3	3	GF26A729.5001	●
Nr. 4 - 40 ¹⁾	0,635	39	28	5,95	2,15	3	3	GF26A729.5003	●
Nr. 6 - 32 ¹⁾	0,794	39	28	7,3	2,7	3	3	GF26A729.5005	●
Nr. 10 - 24 ¹⁾	1,058	42	28	10,1	3,7	4	3	GF26A729.5007	●
1/4 - 20	1,27	55	36	13,2	4,95	6	3	GF26A729.5009	● GF26A129.5009 ●
5/16 - 18	1,411	58	36	16,45	6,3	8	4	GF26A729.5010	● GF26A129.5010 ●
3/8 - 16	1,588	62	36	19,65	7,7	8	4	GF26A729.5011	● GF26A129.5011 ●

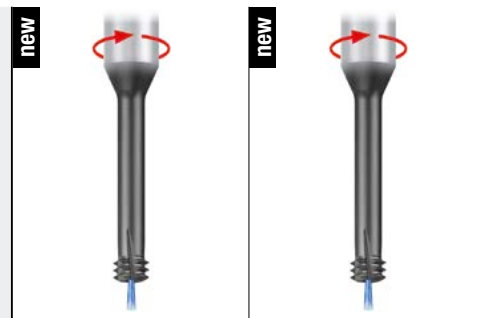
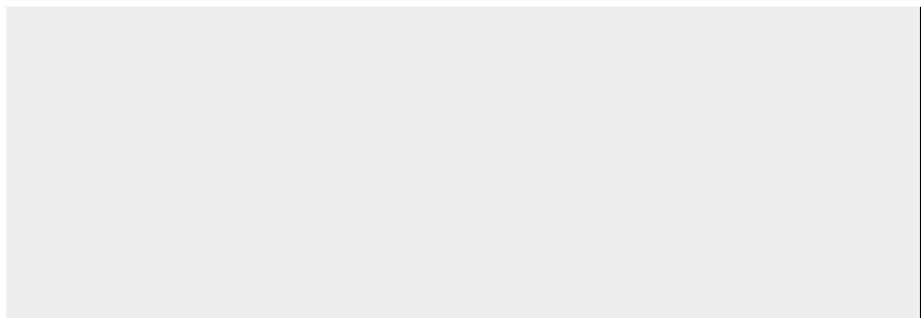

Gewindetiefe
Thread depth

3 x D

Einsatzgebiete – Material
Applications – material

P 1.1-5.1	M 1.1-4.1	K 1.1-4.2
N 1.1-5.2	S 1.1-2.6	H 1.1-2

ø D	P mm	l ₁	l ₃	l ₅	ø d ₁	ø d ₂	Z	ZGF-S-CUT 3xD	
								IKZ-HA TIALN-T46	IKZ-HB TIALN-T46
Nr. 4 - 40 ¹⁾	0,635	41	28	8,9	2,15	3	3	GF2BA729.5003	●
Nr. 6 - 32 ¹⁾	0,794	43	28	10,9	2,7	3	3	GF2BA729.5005	●
Nr. 10 - 24 ¹⁾	1,058	48	28	15	3,7	4	3	GF2BA729.5007	●
1/4 - 20	1,27	61	36	19,7	4,95	6	3	GF2BA729.5009	● GF2BA129.5009 ●
5/16 - 18	1,411	67	36	24,5	6,3	8	4	GF2BA729.5010	● GF2BA129.5010 ●
3/8 - 16	1,588	71	36	29,4	7,7	8	4	GF2BA729.5011	● GF2BA129.5011 ●

¹⁾ Ausführung ohne innere Kühlschmierstoff-Zufuhr IKZ
Design without internal coolant supply IKZ

Andere Ausführungen auf Anfrage
Other designs upon request

Auch für UNF-Gewinde verwendbar
Suitable also for UNF threads

UNF

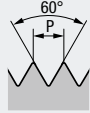

ASME B1.1

Für Innengewinde
For internal threads

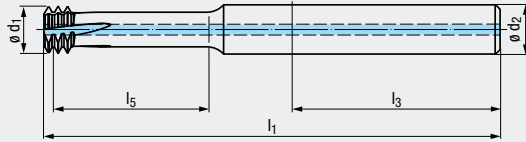

VHM	TIALN T46
RH + LH	LH-rot.
L10	Z3 - Z6
DIN 6535	Ø D
HA HB	



Gewindetiefe
Thread depth

2 x D

Einsatzgebiete – Material
Applications – material

P 1.1-5.1	M 1.1-4.1	K 1.1-4.2
N 1.1-5.2	S 1.1-2.6	H 1.1-2

Ø D	P mm	l ₁	l ₃	l ₅	Ø d ₁	Ø d ₂	Z	ZGF-S-CUT 2xD			
								IKZ-HA TIALN-T46	IKZ-HB TIALN-T46		
Nr. 10 - 32 ¹⁾	0,794	42	28	9,95	3,9	4	4	GF26A729.5041	●	GF26A129.5043	●
1/4 - 28	0,907	55	36	13,1	5,25	6	5	GF26A729.5043	●	GF26A129.5044	●
5/16 - 24	1,058	58	36	16,3	6,6	8	5	GF26A729.5044	●	GF26A129.5046	●
7/16 - 20	1,27	74	40	22,75	9,55	10	6	GF26A729.5046	●	GF26A129.5046	●

new



new

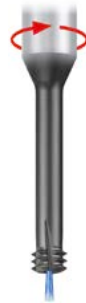

Gewindetiefe
Thread depth

3 x D

Einsatzgebiete – Material
Applications – material

P 1.1-5.1	M 1.1-4.1	K 1.1-4.2
N 1.1-5.2	S 1.1-2.6	H 1.1-2

Ø D	P mm	l ₁	l ₃	l ₅	Ø d ₁	Ø d ₂	Z	ZGF-S-CUT 3xD			
								IKZ-HA TIALN-T46	IKZ-HB TIALN-T46		
Nr. 10 - 32 ¹⁾	0,794	46	28	14,9	3,9	4	4	GF2BA729.5041	●	GF2BA129.5043	●
1/4 - 28	0,907	60	36	19,5	5,25	6	5	GF2BA729.5043	●	GF2BA129.5044	●
5/16 - 24	1,058	66	36	24,3	6,6	8	5	GF2BA729.5044	●	GF2BA129.5046	●
7/16 - 20	1,27	79	40	34	9,55	10	6	GF2BA729.5046	●	GF2BA129.5046	●

¹⁾ Ausführung ohne innere Kühlschmierstoff-Zufuhr IKZ
Design without internal coolant supply IKZ

Andere Ausführungen auf Anfrage
Other designs upon request

G (BSP)

DIN EN ISO 228

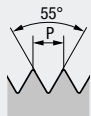

Für Innen- und Außengewinde
For internal and external threads

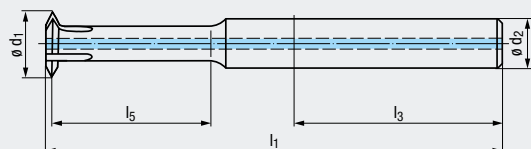

VHM

RH + LH

Z5

DIN 6535

HA

HB



Gewindetiefe
Thread depth

2 x D

Einsatzgebiete – Material
Applications – material



P 1.1-5.1 K 1.1-4.2 N 1.1-5, 2.1-6
N 3.1-2 N 4.1-2, 5.2 S 1.1-3

ø D	P Gg/1" (tpi)	P _{max.} mm	l ₁	l ₃	l ₅	ø d ₁	ø d ₂	Z	ZGF 2xD IKZ-HA		ZGF 2xD IKZ-HB	
									GF253701.4035	●	GF253101.4035	●
G 1/8	28	0,907	62	36	19,9	7,9	8	5	GF253701.4035	●	GF253101.4035	●
G 1/4 - G 3/8	19	1,337	78	40	33,9	9,9	10	5	GF253701.4036	●	GF253101.4036	●

TICN



Einsatzgebiete – Material
Applications – material



P 1.1-5.1 M 1.1-4.1 K 1.1-4.2
N 1.1-5.2 S 1.1-2.6 H 1.1-2

ø D	P Gg/1" (tpi)	P _{max.} mm	l ₁	l ₃	l ₅	ø d ₁	ø d ₂	Z	ZGF 2xD IKZ-HA TICN		ZGF 2xD IKZ-HB TICN	
									GF253706.4035	●	GF253106.4035	●
G 1/8	28	0,907	62	36	19,9	7,9	8	5	GF253706.4035 <td>●</td> <td>GF253106.4035 <td>●</td> </td>	●	GF253106.4035 <td>●</td>	●
G 1/4 - G 3/8	19	1,337	78	40	33,9	9,9	10	5	GF253706.4036 <td>●</td> <td>GF253106.4036 <td>●</td> </td>	●	GF253106.4036 <td>●</td>	●

Andere Ausführungen auf Anfrage
Other designs upon request



Programmierbeispiele (DIN)

Werkzeug: ZGF-VHM-2xD-IKZ-HA-TICN

Programming examples (DIN)

Tool: ZGF-VHM-2xD-IKZ-HA-TICN

Gewinde-Abmessung: Thread dimension:	EG M4 - 4H
Gewinde-Nenndurchmesser D: Nominal thread diameter D:	4,910 mm
Gewindesteigung P: Thread pitch P:	0,700 mm
Kernlochdurchmesser D ₁ : Drilled hole diameter D ₁ :	4,150 mm
Gewindetiefe b ³⁾ : Thread depth b ³⁾ :	8,400 mm
Werkstoff: Material:	AlMgSi (EN AW-6060)
Werkzeug-Abmessungen: Tool dimensions:	∅ 2,78 x 42 mm
Schneidstoff: Cutting material:	Vollhartmetall Solid carbide
Beschichtung: Coating:	TICN
Artikel-Nr.: Article no.:	GF253706.0035
Zähnezahl Z: No. of teeth Z:	3
Fräserdurchmesser d ₁ : Cutter diameter d ₁ :	2,780 mm
Fräserradiuskorrektur k ¹⁾ : Cutter radius compensation k ¹⁾ :	0,049 mm
Zu programmierender Fräserradius ¹⁾ : Cutter radius to be programmed ¹⁾ :	1,341 mm
Schnittgeschwindigkeit v _c : Cutting speed v _c :	180 m/min
Vorschub pro Zahn (Fräsen) f _z : Feed per tooth (milling) f _z :	0,030 mm
Drehzahl n: Speed n:	S = 20620 min⁻¹
Vorschubgeschwindigkeit (Kontur) v _f : Feed speed (contour) v _f :	F = 1856 mm/min
Vorschubgeschwindigkeit (Mittelpunktsbahn) v _{fM} : Feed speed (centre point) v _{fM} :	F = 805 mm/min

(gemessen am Frästeil)
(measured on the cutting part)

(je nach Einsatzfall)
(acc. work case)

(0,5 · d₁ - k)

$$n = \frac{v_c \cdot 1000}{d_1 \cdot \pi}$$

$$v_f = f_z \cdot Z \cdot n$$

$$v_{fM} = \frac{v_f \cdot (D - d_1)}{D}$$

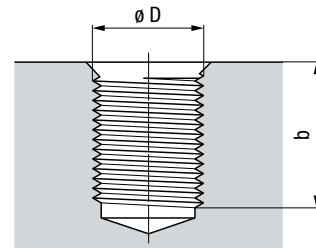
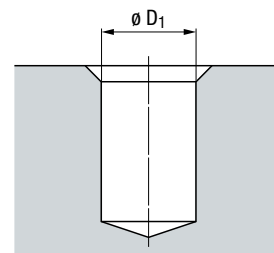

CNC-Innengewindefräsen (im Gegenlauf, an der Kontur, inkremental, nach DIN 66025)

CNC internal thread milling (conventional milling, on the contour, incremental, acc. DIN 66025)

N 10	G 54	G 90	G 00	X...	Y...	Z 0,000	S 20620	T01 ²⁾	M03
N 20	G 91								
N 30	G 42	G 01		X 0	Y -2,455	F 1856 (Kontur · Contour)		[F 805] ⁴⁾	(Mittelpunkt · Centre point)
N 40	G 02			X 0	Y 0	Z -0,700	I 0	J 2,455	
... ⁵⁾									
N 50	G 40	G 01		X 0	Y 2,455				
N 70	G 90	G 00		Z 0,7					

Zerspanzeit t_h: Machining time t _h :	6,0 sec.
Anzahl der Gewindegänge ⁵⁾: Number of threads ⁵⁾ :	11

¹⁾ Der zu programmierende Fräserradius ist je nach Einsatzfall zu korrigieren, bis das Gewinde die gewünschte Muttertoleranz, z.B. 6H/ISO2 erreicht. Die Fräserradiuskorrektur hängt aber auch von der radialen Verdrängung des Werkzeugs ab (Festigkeit des zu fräsenden Materials und Auskrümmung).

²⁾ Der zu programmierende Fräserradius ist üblicherweise im Werkzeugspeicher enthalten.

³⁾ Die eingegebene Gewindetiefe b muss durch die Steigung P teilbar sein.

⁴⁾ Bei Steuerungen, welche die Berechnung des Mittelpunktvorschubs nicht selbstständig durchführen, müssen die Vorschubwerte in Klammern verwendet werden.

⁵⁾ Satz N 40 muss mit Anzahl der Gewindegänge wiederholt werden.

¹⁾ The cutter radius to be programmed must be corrected, depending on the work case, until the thread achieves the required nut tolerance, e.g. 6H/ISO2. Please note, however, that this also depends on the radial deflection of the tool (tensile strength of the material, projection length of the tool).

²⁾ The cutter radius to be programmed is normally included in the tool memory.

³⁾ The thread depth b as entered must be divisible by the pitch P.

⁴⁾ If your control does not calculate the centre point feed automatically please use the feed values printed in brackets.

⁵⁾ Block N 40 must be repeated with the number of threads.

Programmierbeispiele (DIN)

Werkzeug: ZGF-Z-VHM-2xD-IKZ-HA-TICN

Programming examples (DIN)

Tool: ZGF-Z-VHM-2xD-IKZ-HA-TICN

Gewinde-Abmessung: Thread dimension:	M3 - 6H
Gewinde-Nenndurchmesser D: Nominal thread diameter D:	3,000 mm
Gewindesteigung P: Thread pitch P:	0,500 mm
Kernlochdurchmesser D ₁ : Drilled hole diameter D ₁ :	2,500 mm
Gewindetiefe b ³⁾ : Thread depth b ³⁾ :	6,000 mm
Werkstoff: Material:	AlZn5Mg3Cu (EN AW-7022)

Werkzeug-Abmessungen: Tool dimensions:	∅ 2,4 x 39 mm
Schneidstoff: Cutting material:	Vollhartmetall Solid carbide
Beschichtung: Coating:	TICN
Artikel-Nr.: Article no.:	GF293746.0030
Zähnezahl Z: No. of teeth Z:	3
Fräserdurchmesser d ₁ : Cutter diameter d ₁ :	2,400 mm

Fräserradiuskorrektur k ¹⁾ : Cutter radius compensation k ¹⁾ :	0,030 mm	(je nach Einsatzfall) (acc. work case)
Zu programmierender Fräserradius ¹⁾ : Cutter radius to be programmed ¹⁾ :	1,170 mm	(0,5 · d ₁ - k)
Schnittgeschwindigkeit v _c : Cutting speed v _c :	180 m/min	
Vorschub pro Zahn (Fräsen) f _z : Feed per tooth (milling) f _z :	0,040 mm	
Drehzahl n: Speed n:	S = 23885 min ⁻¹	$n = \frac{v_c \cdot 1000}{d_1 \cdot \pi}$
Vorschubgeschwindigkeit (Kontur) v _f : Feed speed (contour) v _f :	F = 2866 mm/min	$v_f = f_z \cdot Z \cdot n$
Vorschubgeschwindigkeit (Mittelpunktsbahn) v _{fM} : Feed speed (centre point) v _{fM} :	F = 573 mm/min	$v_{fM} = \frac{v_f \cdot (D - d_1)}{D}$

(gemessen am Frästeil)
(measured on the cutting part)

(je nach Einsatzfall)
(acc. work case)

(0,5 · d₁ - k)

$$n = \frac{v_c \cdot 1000}{d_1 \cdot \pi}$$

$$v_f = f_z \cdot Z \cdot n$$

$$v_{fM} = \frac{v_f \cdot (D - d_1)}{D}$$

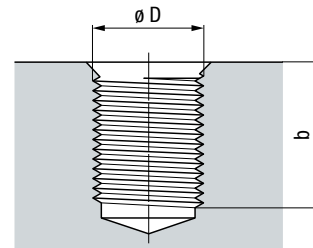
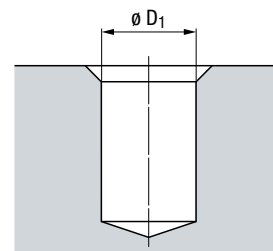

CNC-Innengewindefräsen (im Gegenlauf, an der Kontur, inkremental, nach DIN 66025)

CNC internal thread milling (conventional milling, on the contour, incremental, acc. DIN 66025)

N 10	G 54	G 90	G 00	X...	Y...	Z 0,000	S 23885	T01 ²⁾	M03
N 20	G 91								
N 30	G 42	G 01		X 0	Y -1,5	F 2866 (Kontur · Contour)		[F 573] ⁴⁾	(Mittelpunkt · Centre point)
N 40	G 02			X 0	Y 0	Z -0,500	I 0	J 1,500	
... ⁵⁾									
N 50	G 40	G 01		X 0	Y 1,5				
N 70	G 90	G 00		Z 0,5					

Zerspanzeit t_h: Machining time t _h :	2,4 sec.
--	-----------------

Anzahl der Gewindegänge ⁵⁾: Number of threads ⁵⁾ :	11
--	-----------

¹⁾ Der zu programmierende Fräserradius ist je nach Einsatzfall zu korrigieren, bis das Gewinde die gewünschte Muttertoleranz, z.B. 6H/ISO2 erreicht. Die Fräserradiuskorrektur hängt aber auch von der radialen Verdrängung des Werkzeugs ab (Festigkeit des zu fräsenden Materials und Auskraglänge).

²⁾ Der zu programmierende Fräserradius ist üblicherweise im Werkzeugspeicher enthalten.

³⁾ Die eingegebene Gewindetiefe b muss durch die Steigung P teilbar sein.

⁴⁾ Bei Steuerungen, welche die Berechnung des Mittelpunktvorschubs nicht selbstständig durchführen, müssen die Vorschubwerte in Klammern verwendet werden.

⁵⁾ Satz N 40 muss mit Anzahl der Gewindegänge wiederholt werden.

¹⁾ The cutter radius to be programmed must be corrected, depending on the work case, until the thread achieves the required nut tolerance, e.g. 6H/ISO2. Please note, however, that this also depends on the radial deflection of the tool (tensile strength of the material, projection length of the tool).

²⁾ The cutter radius to be programmed is normally included in the tool memory.

³⁾ The thread depth b as entered must be divisible by the pitch P.

⁴⁾ If your control does not calculate the centre point feed automatically please use the feed values printed in brackets.

⁵⁾ Block N 40 must be repeated with the number of threads.

Programmierbeispiele (DIN)

Werkzeug: ZGF-S-CUT-VHM-2xD-IKZ-HA-TIALN-T46

Programming examples (DIN)

Tool: ZGF-S-CUT-VHM-2xD-IKZ-HA-TIALN-T46

Gewinde-Abmessung: Thread dimension:	M8 - 6H
Gewinde-Nenndurchmesser D: Nominal thread diameter D:	8,000 mm
Gewindesteigung P: Thread pitch P:	1,250 mm
Kernlochdurchmesser D ₁ : Drilled hole diameter D ₁ :	6,750 mm
Gewindetiefe b ³⁾ : Thread depth b ³⁾ :	16,000 mm
Werkstoff: Material:	TiAl6V4 (3.7165)
Werkzeug-Abmessungen: Tool dimensions:	ø 6,5 x 60 mm
Schneidstoff: Cutting material:	Vollhartmetall Solid carbide
Beschichtung: Coating:	TIALN-T46
Artikel-Nr.: Article no.:	GF26A129.0080
Zähnezahl Z: No. of teeth Z:	4
Fräserdurchmesser d ₁ : Cutter diameter d ₁ :	6,500 mm
Fräserradiuskorrektur k ¹⁾ : Cutter radius compensation k ¹⁾ :	0,080 mm
Zu programmierender Fräserradius ¹⁾ : Cutter radius to be programmed ¹⁾ :	3,170 mm
Schnittgeschwindigkeit v _c : Cutting speed v _c :	100 m/min
Vorschub pro Zahn (Fräsen) f _z : Feed per tooth (milling) f _z :	0,080 mm
Drehzahl n: Speed n:	S = 4900 min⁻¹
Vorschubgeschwindigkeit (Kontur) v _f : Feed speed (contour) v _f :	F = 1568 mm/min
Vorschubgeschwindigkeit (Mittelpunktsbahn) v _{fM} : Feed speed (centre point) v _{fM} :	F = 294 mm/min

(gemessen am Frästeil)
(measured on the cutting part)

(je nach Einsatzfall)
(acc. work case)

(0,5 · d₁ - k)

$$n = \frac{v_c \cdot 1000}{d_1 \cdot \pi}$$

$$v_f = f_z \cdot Z \cdot n$$

$$v_{fM} = \frac{v_f \cdot (D - d_1)}{D}$$

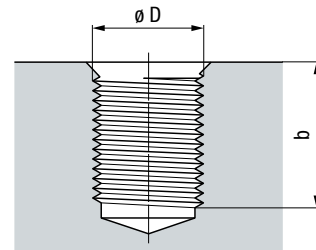
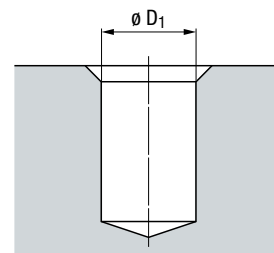

CNC-Innengewindefräsen (im Gegenlauf, an der Kontur, inkremental, nach DIN 66025)

CNC internal thread milling (conventional milling, on the contour, incremental, acc. DIN 66025)

N 10	G 54	G 90	G 00	X...	Y...	Z 0,875	S 4900	T01 ²⁾	M04
N 20	G 91								
N 30	G 42	G 01		X 0	Y -4	F 1568 (Kontur · Contour)		[F 294] ⁴⁾	(Mittelpunkt · Centre point)
N 40	G 02			X 0	Y 0	Z -1,250	I 0	J 4,000	
... ⁵⁾									
N 50	G 40	G 01		X 0	Y 4				
N 70	G 90	G 00		Z 1,25					

Zerspanzeit t_h: Machining time t _h :	14,7 sec.
Anzahl der Gewindegänge ⁵⁾: Number of threads ⁵⁾ :	14

¹⁾ Der zu programmierende Fräserradius ist je nach Einsatzfall zu korrigieren, bis das Gewinde die gewünschte Muttertoleranz, z.B. 6H/ISO2 erreicht. Die Fräserradiuskorrektur hängt aber auch von der radialen Verdrängung des Werkzeugs ab (Festigkeit des zu fräsenden Materials und Auskrümmung).

²⁾ Der zu programmierende Fräserradius ist üblicherweise im Werkzeugspeicher enthalten.

³⁾ Die eingegebene Gewindetiefe b muss durch die Steigung P teilbar sein.

⁴⁾ Bei Steuerungen, welche die Berechnung des Mittelpunktvorschubs nicht selbstständig durchführen, müssen die Vorschubwerte in Klammern verwendet werden.

⁵⁾ Satz N 40 muss mit Anzahl der Gewindegänge wiederholt werden.

¹⁾ The cutter radius to be programmed must be corrected, depending on the work case, until the thread achieves the required nut tolerance, e.g. 6H/ISO2. Please note, however, that this also depends on the radial deflection of the tool (tensile strength of the material, projection length of the tool).

²⁾ The cutter radius to be programmed is normally included in the tool memory.

³⁾ The thread depth b as entered must be divisible by the pitch P.

⁴⁾ If your control does not calculate the centre point feed automatically please use the feed values printed in brackets.

⁵⁾ Block N 40 must be repeated with the number of threads.

Programmierbeispiele (DIN)

Werkzeug: ZGF-HCUT-VHM-2xD-IKZ-HA-TIALN-T46

Programming examples (DIN)

Tool: ZGF-HCUT-VHM-2xD-IKZ-HA-TIALN-T46

Gewinde-Abmessung: Thread dimension:	M6 - 6H
Gewinde-Nenndurchmesser D: Nominal thread diameter D:	6,000 mm
Gewindesteigung P: Thread pitch P:	1,000 mm
Kernlochdurchmesser D ₁ : Drilled hole diameter D ₁ :	5,000 mm
Gewindetiefe b ³⁾ : Thread depth b ³⁾ :	12,000 mm
Werkstoff: Material:	60 HRC

Werkzeug-Abmessungen: Tool dimensions:	∅ 4,8 x 55 mm
Schneidstoff: Cutting material:	Vollhartmetall Solid carbide
Beschichtung: Coating:	TIALN-T46
Artikel-Nr.: Article no.:	GF283729.0060
Zähnezahl Z: No. of teeth Z:	4
Fräserdurchmesser d ₁ : Cutter diameter d ₁ :	4,800 mm

Fräserradiuskorrektur k ¹⁾ : Cutter radius compensation k ¹⁾ :	0,060 mm	(je nach Einsatzfall) (acc. work case)
Zu programmierender Fräserradius ¹⁾ : Cutter radius to be programmed ¹⁾ :	2,340 mm	(0,5 · d ₁ - k)
Schnittgeschwindigkeit v _c : Cutting speed v _c :	40 m/min	
Vorschub pro Zahn (Fräsen) f _z : Feed per tooth (milling) f _z :	0,025 mm	
Drehzahl n: Speed n:	S = 2654 min ⁻¹	$n = \frac{v_c \cdot 1000}{d_1 \cdot \pi}$
Vorschubgeschwindigkeit (Kontur) v _f : Feed speed (contour) v _f :	F = 265 mm/min	$v_f = f_z \cdot Z \cdot n$
Vorschubgeschwindigkeit (Mittelpunktsbahn) v _{fM} : Feed speed (centre point) v _{fM} :	F = 53 mm/min	$v_{fM} = \frac{v_f \cdot (D - d_1)}{D}$

(gemessen am Frästeil)
(measured on the cutting part)

(je nach Einsatzfall)
(acc. work case)

(0,5 · d₁ - k)

$$n = \frac{v_c \cdot 1000}{d_1 \cdot \pi}$$

$$v_f = f_z \cdot Z \cdot n$$

$$v_{fM} = \frac{v_f \cdot (D - d_1)}{D}$$

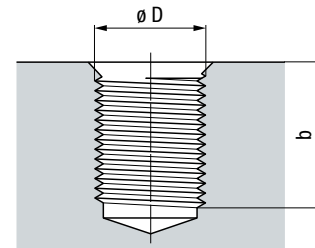
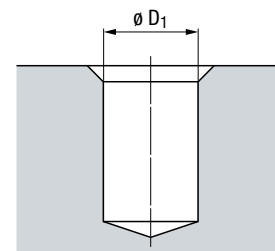

CNC-Innengewindefräsen (im Gegenlauf, an der Kontur, inkremental, nach DIN 66025)

CNC internal thread milling (conventional milling, on the contour, incremental, acc. DIN 66025)

N 10	G 54	G 90	G 00	X...	Y...	Z 0,000	S 2654	T01 ²⁾	M04
N 20	G 91								
N 30	G 42	G 01		X 0	Y -3	F 265 (Kontur · Contour)		[F 955] ⁴⁾	(Mittelpunkt · Centre point)
N 40	G 02			X 0	Y 0	Z -1,500	I 0	J 3,000	
... ⁵⁾									
N 50	G 40	G 01		X 0	Y 3				
N 70	G 90	G 00		Z 1					

Zerspanzeit t_h: Machining time t _h :	51,1 sec.
--	------------------

Anzahl der Gewindegänge ⁵⁾: Number of threads ⁵⁾ :	11
--	-----------

¹⁾ Der zu programmierende Fräserradius ist je nach Einsatzfall zu korrigieren, bis das Gewinde die gewünschte Muttertoleranz, z.B. 6H/ISO2 erreicht. Die Fräserradiuskorrektur hängt aber auch von der radialen Verdrängung des Werkzeugs ab (Festigkeit des zu fräsenden Materials und Auskraglänge).

²⁾ Der zu programmierende Fräserradius ist üblicherweise im Werkzeugspeicher enthalten.

³⁾ Die eingegebene Gewindetiefe b muss durch die Steigung P teilbar sein.

⁴⁾ Bei Steuerungen, welche die Berechnung des Mittelpunktvorschubs nicht selbstständig durchführen, müssen die Vorschubwerte in Klammern verwendet werden.

⁵⁾ Satz N 40 muss mit Anzahl der Gewindegänge wiederholt werden.

¹⁾ The cutter radius to be programmed must be corrected, depending on the work case, until the thread achieves the required nut tolerance, e.g. 6H/ISO2. Please note, however, that this also depends on the radial deflection of the tool (tensile strength of the material, projection length of the tool).

²⁾ The cutter radius to be programmed is normally included in the tool memory.

³⁾ The thread depth b as entered must be divisible by the pitch P.

⁴⁾ If your control does not calculate the centre point feed automatically please use the feed values printed in brackets.

⁵⁾ Block N 40 must be repeated with the number of threads.

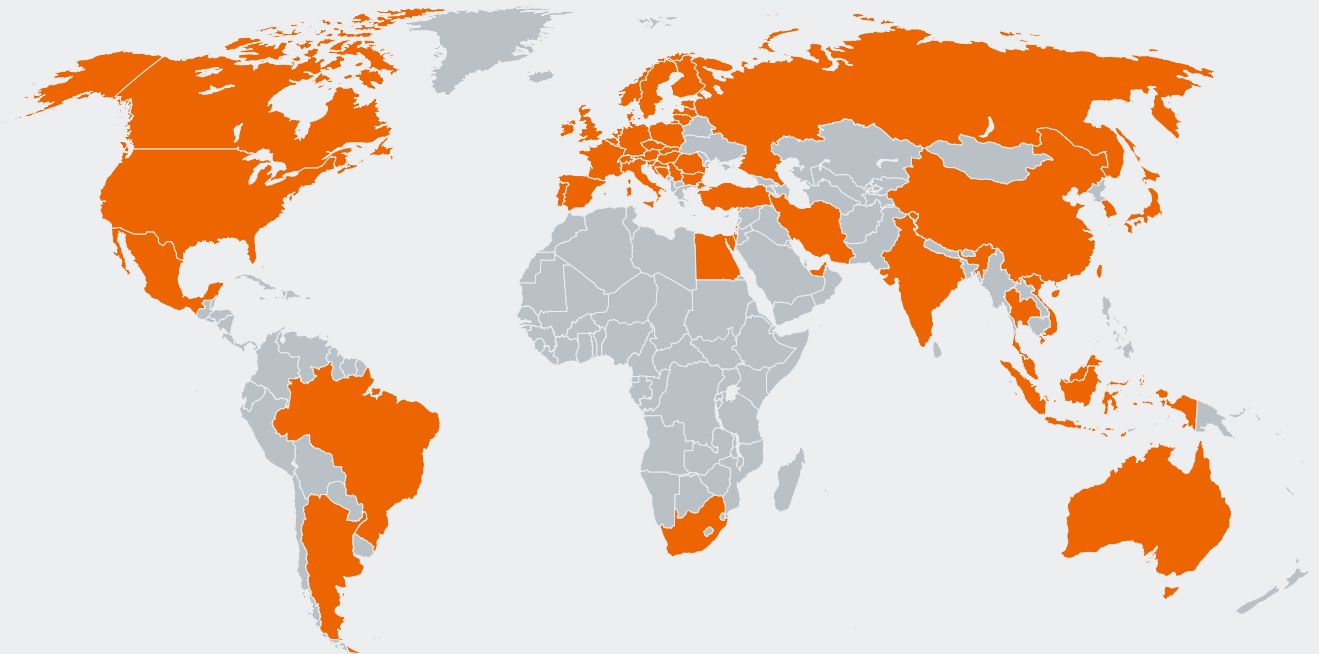

EMUGE-FRANKEN Vertriebspartner finden Sie auf www.emuge-franken.com/vertrieb
EMUGE-FRANKEN sales partners, please see www.emuge-franken.com/sales

EMUGE-Werk Richard Glimpel GmbH & Co. KG
Fabrik für Präzisionswerkzeuge

🏠 Nürnberger Straße 96-100
91207 Lauf
GERMANY

☎ +49 9123 186-0
📠 +49 9123 14313

FRANKEN GmbH & Co. KG
Fabrik für Präzisionswerkzeuge

🏠 Frankenstraße 7/9a
90607 Rückersdorf
GERMANY

☎ +49 911 9575-5
📠 +49 911 9575-327

✉ info@emuge-franken.com 🌐 www.emuge-franken.com